

Capacitance

(1) **Definition** : We know that charge given to a conductor increases its potential i.e., $Q \propto V \Rightarrow Q = CV$

Where C is a proportionality constant, called capacity or capacitance of conductor. Hence capacitance is the ability of conductor to hold the charge.

(2) **Unit and dimensional formula** : S.I. unit is $\frac{\text{Coulomb}}{\text{Volt}} = \text{Farad (F)}$

Smaller S.I. units are mF , μF , nF and pF ($1mF = 10^{-3} F$, $1\mu F = 10^{-6} F$, $1nF = 10^{-9} F$, $1pF = 1\mu\mu F = 10^{-12} F$)

C.G.S. unit is *Stat Farad* $1F = 9 \times 10^{11} \text{ Stat Farad}$. Dimension : $[C] = [M^{-1}L^{-2}T^4A^2]$.

(3) **Capacity of an isolated spherical conductor** : When charge Q is given to a spherical conductor of radius R , then potential at the surface of sphere is

$$V = k \cdot \frac{Q}{R} \quad \left\{ k = \frac{1}{4\pi\epsilon_0} \right\}$$

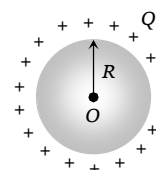

Hence its capacity $C = \frac{Q}{V} = 4\pi\epsilon_0 R \Rightarrow C = 4\pi\epsilon_0 R = \frac{1}{9 \times 10^9} \cdot R$

in C.G.S. $C = R$

Note : □ If earth is assumed to be spherical having radius $R = 6400 \text{ km}$. Its theoretical capacitance $C = \frac{1}{9 \times 10^9} \times 6400 \times 10^3 = 711 \mu F$. But for all practical purpose capacitance of earth is taken infinity.

(4) **Energy of a charged conductor** : When a conductor is charged its potential increases from 0 to V as shown in the graph; and work is done against repulsion, between charge stored in the conductor and charge coming from the source (battery). This work is stored as “electrostatic potential energy”

From graph : Work done = Area of graph = $\frac{1}{2} QV$

Hence potential energy $U = \frac{1}{2} QV$; By using $Q = CV$, we can write

$$U = \frac{1}{2} QV = \frac{1}{2} CV^2 = \frac{Q^2}{2C}$$

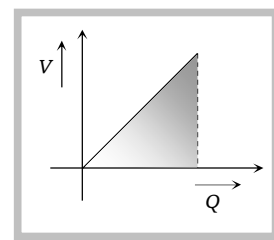

(5) **Combination of drops** : Suppose we have n identical drops each having - Radius - r , Capacitance - c , Charge - q , Potential - v and Energy - u .

If these drops are combined to form a big drop of - Radius - R , Capacitance - C , Charge - Q , Potential - V and Energy - U then -



(i) **Charge on big drop :** $Q = nq$

(ii) **Radius of big drop :** Volume of big drop = $n \times$ volume of a single drop i.e., $\frac{4}{3}\pi R^3 = n \times \frac{4}{3}\pi r^3$,

$$R = n^{1/3}r$$

(iii) **Capacitance of big drop :** $C = n^{1/3}c$

(iv) **Potential of big drop :** $V = \frac{Q}{C} = \frac{nq}{n^{1/3}c}$ $V = n^{2/3}v$

(v) **Energy of big drop :** $U = \frac{1}{2}CV^2 = \frac{1}{2}(n^{1/3}c)(n^{2/3}v)^2$ $U = n^{5/3}u$

(6) **Sharing of charge :** When two conductors joined together through a conducting wire, charge begins to flow from one conductor to another till both have the same potential, due to flow of charge, loss of energy also takes place in the form of heat.

Suppose there are two spherical conductors of radii r_1 and r_2 , having charge Q_1 and Q_2 , potential V_1 and V_2 , energies U_1 and U_2 and capacitance C_1 and C_2 respectively, as shown in figure. If these two spheres are connected through a conducting wire, then alteration of charge, potential and energy takes place.

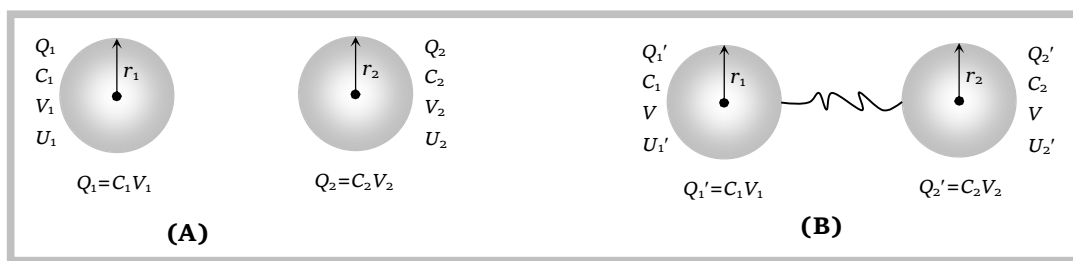

(i) **New charge :** According to the conservation of charge $Q_1 + Q_2 = Q_1' + Q_2' = Q$ (say), also

$$\frac{Q_1'}{Q_2'} = \frac{C_1 V}{C_2 V} = \frac{4\pi\epsilon_0 r_1}{4\pi\epsilon_0 r_2}, \quad \frac{Q_1'}{Q_2'} = \frac{r_1}{r_2} \Rightarrow 1 + \frac{Q_1'}{Q_2'} = 1 + \frac{r_1}{r_2} \Rightarrow \frac{Q_1' + Q_2'}{Q_2'} = \frac{r_1 + r_2}{r_2}$$

$$\Rightarrow Q_2' = Q \left[\frac{r_2}{r_1 + r_2} \right] \quad \text{and similarly } Q_1' = Q \left[\frac{r_1}{r_1 + r_2} \right]$$

(ii) **Common potential :** Common potential $(V) = \frac{\text{Total charge}}{\text{Total capacity}} = \frac{Q_1 + Q_2}{C_1 + C_2} = \frac{Q_1' + Q_2'}{C_1 + C_2} \Rightarrow$

$$V = \frac{C_1 V_1 + C_2 V_2}{C_1 + C_2}$$

(iii) **Energy loss :** As electrical energy stored in the system before and after connecting the spheres is

$$U_i = \frac{1}{2}C_1 V_1^2 + \frac{1}{2}C_2 V_2^2 \quad \text{and} \quad U_f = \frac{1}{2}(C_1 + C_2) \cdot V^2 = \frac{1}{2}(C_1 + C_2) \left(\frac{C_1 V_1 + C_2 V_2}{C_1 + C_2} \right)^2$$



so energy loss $\Delta U = U_i - U_f = \frac{C_1 C_2}{2(C_1 + C_2)} (V_1 - V_2)^2$

Concept

☞ Capacity of a conductor is a constant term, it does not depend upon the charge Q , and potential (V) and nature of the material of the conductor.

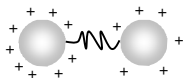

Examples based on sharing of charge, drops and general concept of

Example: 95 Eight drops of mercury of same radius and having same charge coalesce to form a big drop. Capacitance of big drop relative to that of small drop will be

- (a) 16 times (b) 8 times (c) 4 times (d) 2 times

Solution: (d) By using relation $C = n^{1/3} \cdot c \Rightarrow C = (8)^{1/3} \cdot c = 2c$

Example: 96 Two spheres A and B of radius 4 cm and 6 cm are given charges of $80\ \mu\text{C}$ and $40\ \mu\text{C}$ respectively. If they are connected by a fine wire, the amount of charge flowing from one to the other is

[MP PET 1991]

- (a) $20\ \mu\text{C}$ from A to B (b) $16\ \mu\text{C}$ from A to B (c) $32\ \mu\text{C}$ from B to A (d) $32\ \mu\text{C}$ from A to B

Solution: (d) Total charge $Q = 80 + 40 = 120\ \mu\text{C}$. By using the formula $Q_1' = Q \left[\frac{r_1}{r_1 + r_2} \right]$. New charge on sphere A is $Q_A' = Q \left[\frac{r_A}{r_A + r_B} \right] = 120 \left[\frac{4}{4 + 6} \right] = 48\ \mu\text{C}$. Initially it was $80\ \mu\text{C}$, i.e., $32\ \mu\text{C}$ charge flows from A to B .

Example: 97 Two insulated metallic spheres of $3\ \mu\text{F}$ and $5\ \mu\text{F}$ capacitances are charged to 300 V and 500 V respectively. The energy loss, when they are connected by a wire, is

- (a) 0.012 J (b) 0.0218 J (c) 0.0375 J (d) 3.75 J

Solution: (c) By using $\Delta U = \frac{C_1 C_2}{2(C_1 + C_2)} (V_1 - V_2)^2$; $\Delta U = 0.375\text{ J}$

Example: 98 64 small drops of mercury, each of radius r and charge q coalesce to form a big drop. The ratio of the surface density of charge of each small drop with that of the big drop is

- (a) $1 : 64$ (b) $64 : 1$ (c) $4 : 1$ (d) $1 : 4$

Solution: (d) $\frac{\sigma_{\text{Small}}}{\sigma_{\text{Big}}} = \frac{q/4\pi r^2}{Q/4\pi R^2} = \left(\frac{q}{Q} \right) \left(\frac{R}{r} \right)^2$; since $R = n^{1/3}r$ and $Q = nq$

$$\text{So } \frac{\sigma_{\text{Small}}}{\sigma_{\text{Big}}} = \frac{1}{n^{1/3}} \Rightarrow \frac{\sigma_{\text{Small}}}{\sigma_{\text{Big}}} = \frac{1}{4}$$

Tricky example: 14

Two hollow spheres are charged positively. The smaller one is at 50 V and the bigger one is at 100 V . How should they be arranged so that the charge flows from the



smaller to the bigger sphere when they are connected by a wire

- (a) By placing them close to each other
- (b) By placing them at very large distance from each other
- (c) By placing the smaller sphere inside the bigger one
- (d) Information is insufficient

Solution: (c) By placing the smaller sphere inside the bigger one. The potential of the smaller one will now be 150 V. So on connecting it with the bigger one charge will flow from the smaller one to the bigger one.

Capacitor

(1) **Definition :** A capacitor is a device that stores electric energy. It is also named condenser.

or

A capacitor is a pair of two conductors of any shape, which are close to each other and have equal and opposite charge.

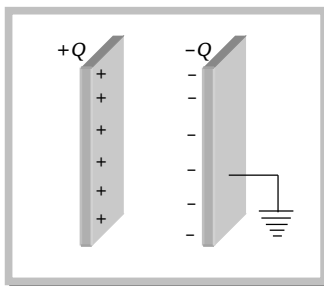

(2) **Symbol :** The symbol of capacitor are shown below



(3) **Capacitance :** The capacitance of a capacitor is defined as the magnitude of the charge Q on the positive plate divided by the magnitude of the potential difference V between the plates i.e., $C = \frac{Q}{V}$

(4) **Charging :** A capacitor gets charged when a battery is connected across the plates. The plate attached to the positive terminal of the battery gets positively charged and the one joined to the negative terminal gets negatively charged. Once capacitor gets fully charged, flow of charge carriers stops in the circuit and in this condition potential difference across the plates of capacitor is same as the potential difference across the terminals of battery (say V).

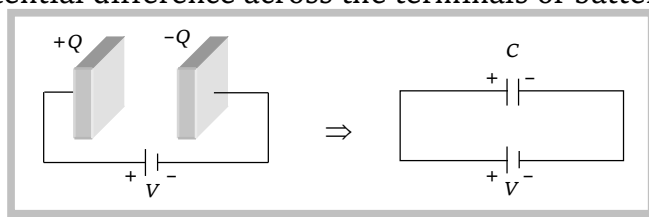

(5) **Charge on capacitor** : Net charge on a capacitor is always zero, but when we speak of the charge Q on a capacitor, we are referring to the magnitude of the charge on each plate. Charge distribution in making of parallel plate capacitor can easily be understood by reading carefully the following sequence of figures -

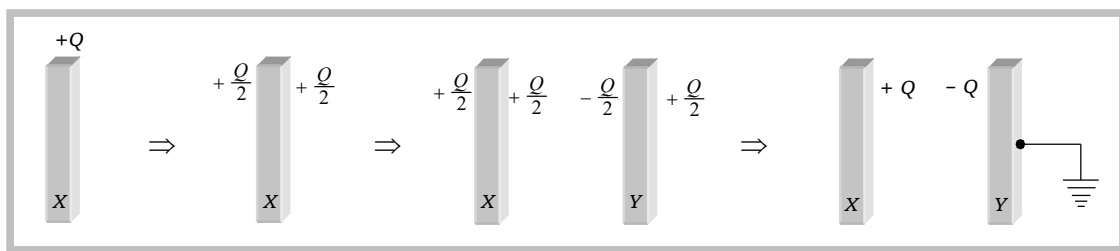

(6) **Energy stored** : When a capacitor is charged by a voltage source (say battery) it stores the electric energy. If C = Capacitance of capacitor; Q = Charge on capacitor and V = Potential difference across capacitor then energy stored in capacitor $U = \frac{1}{2}CV^2 = \frac{1}{2}QV = \frac{Q^2}{2C}$

Note : □ In charging capacitor by battery half the energy supplied is stored in the capacitor and remaining half energy ($1/2 QV$) is lost in the form of heat.

(7) **Types of capacitors** : Capacitors are of mainly three types as described in given table

Parallel Plate Capacitor	Spherical Capacitor	Cylindrical Capacitor
<p>It consists of two parallel metallic plates (may be circular, rectangular, square) separated by a small distance</p> <p>A = Effective overlapping area of each plate d = Separation between the plates Q = Magnitude of charge on the inner side of each plate</p>	<p>It consists of two concentric conducting spheres of radii a and b ($a < b$). Inner sphere is given charge $+Q$, while outer sphere is earthed</p> <p>Capacitance $C = 4\pi\epsilon_0 \cdot \frac{ab}{b-a}$ in C.G.S. $C = \frac{ab}{b-a}$. In the presence of dielectric medium (dielectric constant K) between</p>	<p>It consists of two concentric cylinders of radii a and b ($a < b$), inner cylinder is given charge $+Q$ while outer cylinder is earthed. Common length of the cylinders is l then</p> <p>Capacitance $C = \frac{2\pi\epsilon_0 l}{\log_e \left(\frac{b}{a} \right)}$ In the presence of dielectric</p>



σ = Surface density of charge of each plate $\left(= \frac{Q}{A} \right)$

V = Potential difference across the plates

E = Electric field between the plates $\left(= \frac{\sigma}{\epsilon_0} \right)$

Capacitance : $C = \frac{\epsilon_0 A}{d}$

in C.G.S. : $C = \frac{A}{4\pi d}$

If a dielectric medium of dielectric constant K is filled completely between the plates then capacitance increases by K times $C' = KC$

the spheres $C' = 4\pi\epsilon_0 K \frac{ab}{b-a}$

Special Case :

If outer sphere is given a charge $+Q$ while inner sphere is earthed

Induced charge on the inner sphere

$$Q' = -\frac{a}{b} \cdot Q, \quad C' = 4\pi\epsilon_0 \cdot \frac{b^2}{b-a}$$

This arrangement is not a capacitor. But its capacitance is equivalent to the sum of capacitance of spherical capacitor and spherical conductor *i.e.*

$$4\pi\epsilon_0 \cdot \frac{b^2}{b-a} = 4\pi\epsilon_0 \frac{ab}{b-a} + 4\pi\epsilon_0 b$$

medium (dielectric constant K) capacitance increases by K times and

$$C' = \frac{2\pi\epsilon_0 Kl}{\log_e \left(\frac{b}{a} \right)}$$

Concepts

- It is a very common misconception that a capacitor stores charge but actually a capacitor stores electric energy in the electrostatic field between the plates.
- Two plates of unequal area can also form a capacitor because effective overlapping area is considered.

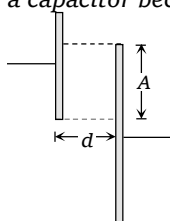

- If two plates are placed side by side then three capacitors are formed. One between distant earthed bodies and the first face of the first plate, the second between the two plates and the third between the second face of the second plate and distant earthed objects. However the capacitances of the first and third capacitors are negligibly small in comparison to that between the plates which is the main capacitance.
- Capacitance of a parallel plate capacitor depends upon the effective overlapping area of plates ($C \propto A$), separation between the plates $\left(C \propto \frac{1}{d} \right)$ and dielectric medium filled between the plates. While it is independent of charge given, potential raised or nature of metals and thickness of plates.
- The distance between the plates is kept small to avoid fringing or edge effect (non-uniformity of the field) at the boundaries of the plates.

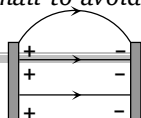

- ☞ Spherical conductor is equivalent to a spherical capacitor with its outer sphere of infinite radius.
- ☞ A spherical capacitor behaves as a parallel plate capacitor if its spherical surfaces have large radii and are close to each other.
- ☞ The intensity of electric field between the plates of a parallel plate capacitor ($E = \sigma/\epsilon_0$) does not depend upon the distance between them.
- ☞ The plates of a parallel plate capacitor are being moved away with some velocity. If the plate separation at any instant of time is 'd' then the rate of change of capacitance with time is proportional to $\frac{1}{d^2}$.
- ☞ Radial and non-uniform electric field exists between the spherical surfaces of spherical capacitor.
- ☞ Two large conducting plates X and Y kept close to each other. The plate X is given a charge Q_1 while plate Y is given a charge Q_2 ($Q_1 > Q_2$), the distribution of charge on the four faces a, b, c, d will be as shown in the following figure.



Example based on simple concepts of

Example: 99 The capacity of pure capacitor is 1 farad. In D.C. circuit, its effective resistance will be

- (a) Zero (b) Infinite (c) 1 ohm (d) $\frac{1}{2}$ ohm

Solution: (b) Capacitor does not work in D.C. for D.C. its effective resistance is infinite i.e. it blocks the current to flow in the circuit.

Example: 100 A light bulb, a capacitor and a battery are connected together as shown here, with switch S initially open. When the switch S is closed, which one of the following is true

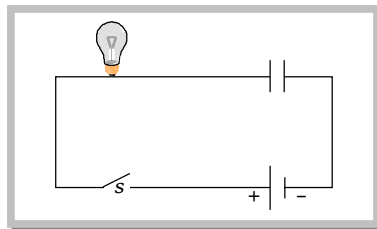

- (a) The bulb will light up for an instant when the capacitor starts charging

(b) The bulb will light up when the capacitor is fully charged

(c) The bulb will not light up at all

(d) The bulb will light up and go off at regular intervals

Solution: (a) Current through the circuit can flow only for the small time of charging, once capacitor gets charged it blocks the current through the circuit and bulb will go off.

Example: 101 Capacity of a parallel plate condenser is $10\mu F$ when the distance between its plates is 8 cm . If the distance between the plates is reduced to 4 cm , its capacity will be

[CBSE 2001; Similar to CPMT 1997; AFMC 2000]

(a) $10\mu F$

(b) $15\mu F$

(c) $20\mu F$

(d) $40\mu F$

Solution: (c) $C = \frac{\epsilon_0 A}{d} \propto \frac{1}{d}$ $\therefore \frac{C_1}{C_2} = \frac{d_2}{d_1}$ or $C_2 = \frac{d_1}{d_2} \times C_1 = \frac{8}{4} \times 10 = 20\mu F$

Example: 102 What is the area of the plates of a 3 F parallel plate capacitor, if the separation between the plates is 5 mm

[BHU 2002; AIIMS 1998]

(a) $1.694 \times 10^9\text{ m}^2$

(b) $4.529 \times 10^9\text{ m}^2$

(c) $9.281 \times 10^9\text{ m}^2$

(d) $12.981 \times 10^9\text{ m}^2$

Solution: (a) By using the relation $C = \frac{\epsilon_0 A}{d} \Rightarrow A = \frac{Cd}{\epsilon_0} = \frac{3 \times 5 \times 10^{-3}}{8.85 \times 10^{-12}} = 1.694 \times 10^9\text{ m}^2$.

Example: 103 If potential difference of a condenser ($6\mu F$) is changed from 10 V to 20 V then increase in energy is

[CPMT 1997, 87]

(a) $2 \times 10^{-4}\text{ J}$

(b) $4 \times 10^{-4}\text{ J}$

(c) $3 \times 10^{-4}\text{ J}$

(d) $9 \times 10^{-4}\text{ J}$

Solution: (d) Initial energy $U_i = \frac{1}{2}CV_i^2$; Final energy $U_f = \frac{1}{2}CV_f^2$

\therefore Increase in energy $\Delta U = U_f - U_i = \frac{1}{2}C(V_f^2 - V_i^2) = \frac{1}{2} \times 6 \times 10^{-6} (20^2 - 10^2) = 9 \times 10^{-4}\text{ J}$.

Example: 104 A spherical capacitor consists of two concentric spherical conductors. The inner one of radius R_1 maintained at potential V_1 and the outer conductor of radius R_2 at potential V_2 . The potential at a point P at a distance x from the centre (where $R_2 > x > R_1$) is

(a) $\frac{V_1 - V_2}{R_2 - R_1}(x - R_1)$

(b) $\frac{V_1 R_1 (R_2 - x) + V_2 R_2 (x - R_1)}{(R_2 - R_1)x}$

(c) $V_1 + \frac{V_2 x}{(R_2 - R_1)}$

(d) $\frac{(V_1 + V_2)}{(R_1 + R_2)}x$

Solution: (b) Let Q_1 and Q_2 be the charges on the inner and the outer sphere respectively. Now V_1 is the total potential on the sphere of radius R_1 ,

So, $V_1 = \frac{Q_1}{R_1} + \frac{Q_2}{R_2}$ (i)

and V_2 is the total potential on the surface of sphere of radius R_2 ,



$$\text{So, } V_2 = \frac{Q_2}{R_2} + \frac{Q_1}{R_2} \quad \dots\dots\dots \text{(ii)}$$

If V be the potential at point P which lies at a distance x from the common centre then

$$V = \frac{Q_1}{x} + \frac{Q_2}{R_2} = \frac{Q_1}{x} + V_1 - \frac{Q_1}{R_1} = Q_1 \left(\frac{1}{x} - \frac{1}{R_1} \right) + V_1 = \frac{Q_1(R_1 - x)}{xR_1} + V_1 \quad \dots\dots\dots \text{(iii)}$$

Subtracting (ii) from (i)

$$V_1 - V_2 = \frac{Q_1}{R_1} - \frac{Q_2}{R_2} \Rightarrow (V_1 - V_2)R_1R_2 = R_2Q_1 - R_1Q_1 \Rightarrow Q_1 = \frac{(V_1 - V_2)R_1R_2}{R_2 - R_1}$$

Now substituting it in equation (iii), we have

$$V = \frac{(R_1 - x)(V_1 - V_2)R_1R_2}{xR_1(R_2 - R_1)} + V_1 \Rightarrow V = \frac{V_1R_1(R_2 - x) + V_2R_2(x - R_1)}{x(R_2 - R_1)}$$

Example: 105 The diameter of each plate of an air capacitor is 4 cm. To make the capacity of this plate capacitor equal to that of 20 cm diameter sphere, the distance between the plates will be

- (a) $4 \times 10^{-3} \text{ m}$ (b) $1 \times 10^{-3} \text{ m}$ (c) 1 cm (d) $1 \times 10^{-3} \text{ cm}$

Solution: (b) According to the question $\frac{\epsilon_0 A}{d} = 4\pi\epsilon_0 R \Rightarrow d = \frac{A}{4\pi R} = \frac{\pi(2 \times 10^{-2})^2}{4\pi \times 10 \times 10^{-2}} = 1 \times 10^{-3} \text{ m}$.

Example: 106 A spherical condenser has inner and outer spheres of radii a and b respectively. The space between the two is filled with air. The difference between the capacities of two condensers formed when outer sphere is earthed and when inner sphere is earthed will be

- (a) Zero (b) $4\pi\epsilon_0 a$ (c) $4\pi\epsilon_0 b$ (d) $4\pi\epsilon_0 a \left(\frac{b}{b-a} \right)$

Solution: (c) Capacitance when outer sphere is earthed $C_1 = 4\pi\epsilon_0 \cdot \frac{ab}{b-a}$ and capacitance when inner sphere is earthed $C_2 = 4\pi\epsilon_0 \cdot \frac{b^2}{b-a}$. Hence $C_2 - C_1 = 4\pi\epsilon_0 \cdot b$

Example: 107 After charging a capacitor of capacitance $4 \mu\text{F}$ upto a potential 400 V, its plates are connected with a resistance of $1 \text{ k}\Omega$. The heat produced in the resistance will be

- (a) 0.16 J (b) 1.28 J (c) 0.64 J (d) 0.32 J

Solution: (d) This is the discharging condition of capacitor and in this condition energy released

$$U = \frac{1}{2} CV^2 = \frac{1}{2} \times 4 \times 10^{-6} \times (400)^2 = 0.32 \text{ J} = 0.32 \text{ J}$$

Example: 108 The amount of work done in increasing the voltage across the plates of a capacitor from 5 V to 10 V is W . The work done in increasing it from 10 V to 15 V will be

- (a) 0.6 W (b) W (c) 1.25 W (d) 1.67 W

Solution: (d) As we know that work done $= U_{final} - U_{initial} = \frac{1}{2} C(V_2^2 - V_1^2)$

When potential difference increases from 5 V to 10 V then

$$W = \frac{1}{2} C(10^2 - 5^2) \quad \dots\dots\dots \text{(i)}$$

When potential difference increases from 10 V to 15 V then

$$W' = \frac{1}{2} C(15^2 - 10^2) \quad \dots\dots\dots \text{(ii)}$$

On solving equation (i) and (ii) we get

$$W' = 1.67 W.$$

Tricky example: 15

In an isolated parallel plate capacitor of capacitance C , the four surface have charges Q_1 , Q_2 , Q_3 and Q_4 as shown. The potential difference between the plates is

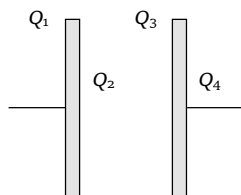

- (a) $\frac{Q_1 + Q_2 + Q_3 + Q_4}{2C}$ (b) $\frac{Q_2 + Q_3}{2C}$ (c) $\frac{Q_2 - Q_3}{2C}$ (d) $\frac{Q_1 + Q_4}{2C}$

Solution: (c) Plane conducting surfaces facing each other must have equal and opposite charge densities. Here as the plate areas are equal, $Q_2 = -Q_3$.

The charge on a capacitor means the charge on the inner surface of the positive plate (here it is Q_2)

$$\begin{aligned} \text{Potential difference between the plates} &= \frac{\text{charge}}{\text{capacitance}} = \frac{Q_2}{C} = \frac{2Q_2}{2C} \\ &= \frac{Q_2 - (-Q_2)}{2C} = \frac{Q_2 - Q_3}{2C}. \end{aligned}$$

Dielectric

Dielectrics are insulating (non-conducting) materials which transmit electric effect without conducting. We know that in every atom, there is a positively charged nucleus and a negatively charged electron cloud surrounding it. The two oppositely charged regions have their own centres of charge. The centre of positive charge is the centre of mass of positively charged protons in the nucleus. The centre of negative charge is the centre of mass of negatively charged electrons in the atoms/molecules.

(1) **Type of Dielectrics :** Dielectrics are of two types -

(i) **Polar dielectrics :** Like water, Alcohol, CO_2 , NH_3 , HCl etc. are made of polar atoms/molecules.

In polar molecules when no electric field is applied, the centre of positive charges does not coincide with the centre of negative charges.

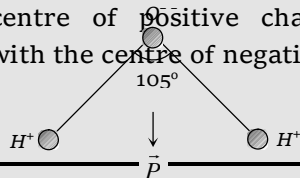

(ii) **Non polar dielectric :** Like N_2 , O_2 , Benzene, Methane etc. are made of non-polar atoms/molecules. In non-polar molecules, when no electric field is applied, the centre of positive charge coincides with the centre of negative charge in the molecule. Each molecule has zero dipole moment in its normal state.

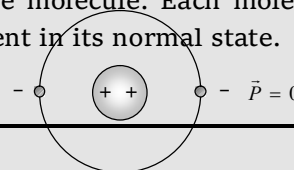

A polar molecule has permanent electric dipole moment (\vec{p}) in the absence of electric field also. But a polar dielectric has net dipole moment is zero in the absence of electric field because polar molecules are randomly oriented as shown in figure.

In the presence of electric field polar molecules tends to line up in the direction of electric field, and the substance has finite dipole moment.

When electric field is applied, positive charge experiences a force in the direction of electric field and negative charge experiences a force in the direction opposite to the field *i.e.*, molecules becomes induced electric dipole.

Note : □ In general, any non-conducting, material can be called as a dielectric but broadly non conducting material having non polar molecules referred to as dielectric because induced dipole moment is created in the non polar molecule.

(2) **Polarization of a dielectric slab** : It is the process of inducing equal and opposite charges on the two faces of the dielectric on the application of electric field.

Suppose a dielectric slab is inserted between the plates of a capacitor. As shown in the figure.

Induced electric field inside the dielectric is E_i , hence this induced electric field decreases the main field E to $E - E_i$ *i.e.*, New electric field between the plates will be $E' = E - E_i$.

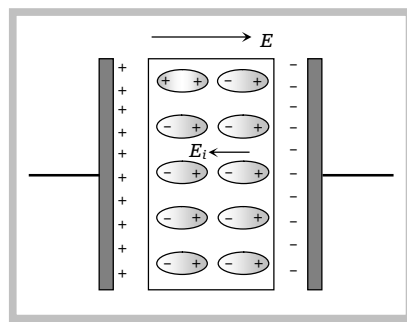

(3) **Dielectric constant** : After placing a dielectric slab in an electric field. The net field is decreased in that region hence

If E = Original electric field and E' = Reduced electric field. Then $\frac{E}{E'} = K$ where K is called dielectric constant

K is also known as relative permittivity (ϵ_r) of the material or **SIC** (Specific Inductive Capacitance)

The value of K is always greater than one. For vacuum there is no polarization and hence $E = E'$ and $K = 1$

(4) **Dielectric breakdown and dielectric strength** : If a very high electric field is created in a dielectric, the outer electrons may get detached from their parent atoms. The dielectric then behaves like a conductor. This phenomenon is known as **dielectric breakdown**.

The maximum value of electric field (or potential gradient) that a dielectric material can tolerate without it's electric breakdown is called it's **dielectric strength**.

S.I. unit of dielectric strength of a material is $\frac{V}{m}$ but practical unit is $\frac{kV}{mm}$.

Variation of Different Variables (Q , C , V , E and U) of Parallel Plate Capacitor

Suppose we have an air filled charged parallel plate capacitor having variables are as follows :

Charge - Q , Surface charge density - $\sigma = \frac{Q}{A}$, Capacitance - $C = \frac{\epsilon_0 A}{d}$

Potential difference across the plates - $V = E.d$

Electric field between the plates - $E = \frac{\sigma}{\epsilon_0} = \frac{Q}{A\epsilon_0}$

Energy stored - $U = \frac{1}{2} CV^2 = \frac{Q^2}{2C} = \frac{1}{2} QV$

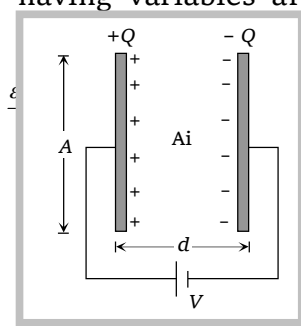

(1) **When dielectric is completely filled between plates** : If a dielectric slab is fills completely the gap between the plates, capacitance increases by K times i.e., $C' = \frac{K\epsilon_0 A}{d} \Rightarrow$

$$C' = KC$$

The effect of dielectric on other variables such as charge. Potential difference field and energy associated with a capacitor depends on the fact that whether the charged capacitor is disconnected from the battery or battery is still connected.

Quantity	Battery is Removed	Battery Remains connected
Capacity	$C' = KC$	$C' = KC$
Charge	$Q' = Q$ (Charge is conserved)	$Q' = KQ$
Potential	$V' = V/K$	$V' = V$ (Since Battery maintains the potential difference)
Intensity	$E' = E/K$	$E' = E$



Energy

$$U' = U/K$$

$$U' = U/K$$

Note : □ If nothing is said it is to be assumed that battery is disconnected.

(2) **When dielectric is partially filled between the plates :** If a dielectric slab of thickness $t (t < d)$ is inserted between the plates as shown below, then E = Main electric field between the plates, E_i = Induced electric field in dielectric. $E' = (E - E_i)$ = The reduced value of electric field in the dielectric. Potential difference between the two plates of capacitor is given by

$$V' = E(d - t) + E't = E(d - t) + \frac{E}{K} \cdot t$$

$$\Rightarrow V' = E \left(d - t + \frac{t}{K} \right) = \frac{\sigma}{\epsilon_0} \left(d - t + \frac{t}{K} \right) = \frac{Q}{A \epsilon_0} \left(d - t + \frac{t}{K} \right)$$

Now capacitance of the capacitor

$$C' = \frac{Q}{V'} \Rightarrow C' = \frac{\epsilon_0 A}{d - t + \frac{t}{K}}$$

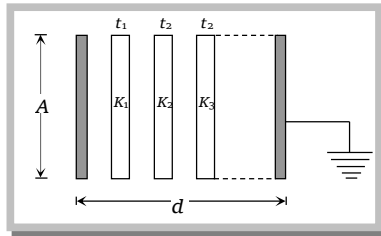
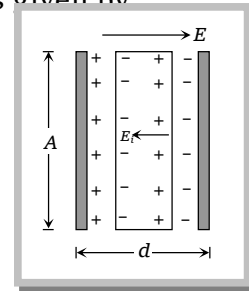

$$C' = \frac{\epsilon_0 A}{d - (t_1 + t_2 + t_3 + \dots) + \left(\frac{t_1}{K_1} + \frac{t_2}{K_2} + \frac{t_3}{K_3} + \dots \right)}$$

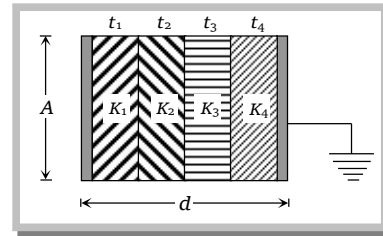

$$C' = \frac{\epsilon_0 A}{\left(\frac{t_1}{K_1} + \frac{t_2}{K_2} + \frac{t_3}{K_3} + \frac{t_4}{K_4} \right)}$$

(3) **When a metallic slab is inserted between the plates :**

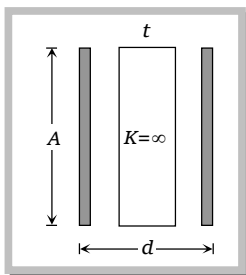

$$\text{Capacitance } C' = \frac{\epsilon_0 A}{(d - t)}$$

circuited)

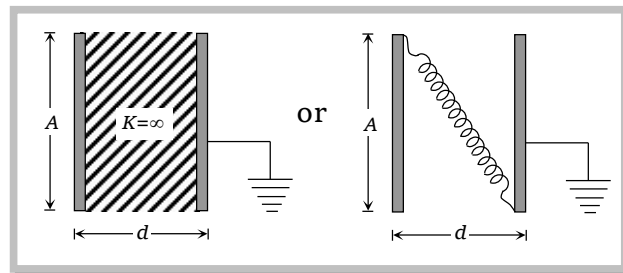

$$C' = \infty \text{ (In this case capacitor is said to be short circuited)}$$



(4) **When separation between the plates is changing** : If separation between the plates changes then its capacitance also changes according to $C \propto \frac{1}{d}$. The effect on other variables depends on the fact that whether the charged capacitor is disconnected from the battery or battery is still connected.

(i) **Separation is increasing**

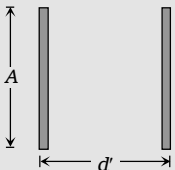
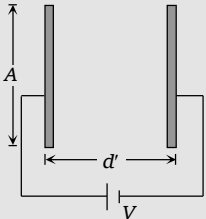
Quantity	Battery is removed	Battery remains connected
		
Capacity	Decreases because $C \propto \frac{1}{d}$ i.e., $C' < C$	Decreases i.e., $C' < C$
Charge	Remains constant because a battery is not present i.e., $Q' = Q$	Decreases because battery is present i.e., $Q' < Q$ Remaining charge $(Q - Q')$ goes back to the battery.
Potential difference	Increases because $V = \frac{Q}{C} \Rightarrow V \propto \frac{1}{C}$ i.e., $V' > V$	$V' = V$ (Since Battery maintains the potential difference)
Electric field	Remains constant because $E = \frac{\sigma}{\epsilon_0} = \frac{Q}{A\epsilon_0}$ i.e., $E' = E$	Decrease because $E = \frac{Q}{A\epsilon_0} \Rightarrow E \propto Q$ i.e., $E' < E$
Energy	Increases because $U = \frac{Q^2}{2C} \Rightarrow U \propto \frac{1}{C}$ i.e., $U' > U$	Decreases because $U = \frac{1}{2}CV^2 \Rightarrow U \propto C$ i.e., $U' < U$

(ii) **Separation is decreasing**

Quantity	Battery is removed	Battery remains connected
Capacity	Increases because $C \propto \frac{1}{d}$ i.e., $C' > C$	Increases i.e., $C' > C$
Charge	Remains constant because battery is not present	Increases because battery is present i.e., $Q' > Q$



	i.e., $Q' = Q$	Remaining charge $(Q' - Q)$ supplied from the battery.
Potential difference	Decreases because $V = \frac{Q}{C} \Rightarrow V \propto \frac{1}{C}$ i.e., $V' < V$	$V' = V$ (Since Battery maintains the potential difference)
Electric field	Remains constant because $E = \frac{\sigma}{\epsilon_0} = \frac{Q}{A\epsilon_0}$ i.e., $E' = E$	Increases because $E = \frac{Q}{A\epsilon_0} \Rightarrow E \propto Q$ i.e., $E' > E$
Energy	Decreases because $U = \frac{Q^2}{2C} \Rightarrow U \propto \frac{1}{C}$ i.e., $U' < U$	Increases because $U = \frac{1}{2} CV^2 \Rightarrow U \propto C$ i.e., $U' > U$

Force Between the Plates of a Parallel Plate Capacitor

Field due to charge on one plate on the other is $E = \frac{\sigma}{2\epsilon_0}$, hence the force $F = QE$

$$F = -\sigma A \times \left(\frac{\sigma}{2\epsilon_0} \right) = -\frac{\sigma^2}{2\epsilon_0} A$$

$$\Rightarrow |F| = \frac{\sigma^2 A}{2\epsilon_0} = \frac{Q^2}{2\epsilon_0 A}$$

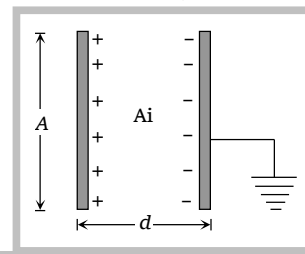

Energy Density Between the Plates of a Parallel Plate Capacitor

The energy stored in a capacitor is not localised on the charges or the plates but is distributed in the field. And as in case of a parallel plate capacitor field is only between the plates i.e. in a volume $(A \times d)$, the so called **energy density**.

$$\text{Hence Energy density} = \frac{\text{Energy}}{\text{Volume}} = \frac{\frac{1}{2} CV^2}{Ad} = \frac{1}{2} \left[\frac{\epsilon_0 A}{d} \right] \frac{V^2}{Ad} = \frac{1}{2} \epsilon_0 \left(\frac{V}{d} \right)^2 = \frac{1}{2} \epsilon_0 E^2.$$

Concepts

☞ In the expression of capacitance of parallel plate capacitor filled partially with dielectric term $\left(d - t + \frac{t}{K} \right)$ is known as effective air separation between the plates.

☞ When dielectric is partially filled between the plates of a parallel plate capacitor then its capacitance increases but potential difference decreases. To maintain the capacitance and potential difference of capacitor as before (i.e., $C = \frac{\epsilon_0 A}{d}$, $V = \frac{\sigma}{\epsilon_0} d$) separation between the plates has to be increased. Suppose separation is

increased by d' so in this case $\frac{\epsilon_0 A}{\left(d + d' - t + \frac{t}{K} \right)} = \frac{\epsilon_0 A}{d}$ which gives us $K = \frac{t}{t - d'}$



Example based on capacitor with



Example: 109 The mean electric energy density between the plates of a charged capacitor is (here Q = Charge on the capacitor and A = Area of the capacitor plate)

- (a) $\frac{Q^2}{2\epsilon_0 A^2}$ (b) $\frac{Q}{2\epsilon_0 A^2}$ (c) $\frac{Q^2}{2\epsilon_0 A}$ (d) None of these

Solution: (a) Energy density $= \frac{1}{2} \epsilon_0 E^2 = \frac{1}{2} \epsilon_0 \left(\frac{Q}{A \epsilon_0} \right)^2 = \frac{Q^2}{2\epsilon_0 A^2}$.

Example: 110 Plate separation of a $15 \mu F$ capacitor is 2 mm . A dielectric slab ($K = 2$) of thickness 1 mm is inserted between the plates. Then new capacitance is given by

- (a) $15 \mu F$ (b) $20 \mu F$ (c) $30 \mu F$ (d) $25 \mu F$

Solution: (b) Given $C = \frac{\epsilon_0 A}{d} = 15 \mu F$ (i)

Then by using $C' = \frac{\epsilon_0 A}{d - t + \frac{t}{K}} = \frac{\epsilon_0 A}{2 \times 10^{-3} - 10^{-3} + \frac{10^{-3}}{2}} = \frac{2}{3} \times \epsilon_0 A \times 10^3$; From equation (i) $C' = 20 \mu F$.

Example: 111 There is an air filled 1 pF parallel plate capacitor. When the plate separation is doubled and the space is filled with wax, the capacitance increases to 2 pF . The dielectric constant of wax is

[MNR 1998]

- (a) 2 (b) 4 (c) 6 (d) 8

Solution: (b) Given that capacitance $C = 1 \text{ pF}$

After doubling the separation between the plates $C' = \frac{C}{2}$

and when dielectric medium of dielectric constant k filled between the plates then $C' = \frac{KC}{2}$

According to the question, $C' = \frac{KC}{2} = 2 \Rightarrow K = 4$.

Example: 112 If a slab of insulating material $4 \times 10^{-5} \text{ m}$ thick is introduced between the plate of a parallel plate capacitor, the distance between the plates has to be increased by $3.5 \times 10^{-5} \text{ m}$ to restore the capacity to original value. Then the dielectric constant of the material of slab is

- (a) 10 (b) 12 (c) 6 (d) 8

Solution: (d) By using $K = \frac{t}{t - d'}$; here $t = 4 \times 10^{-5} \text{ m}$; $d' = 3.5 \times 10^{-5} \text{ m} \Rightarrow K = \frac{4 \times 10^{-5}}{4 \times 10^{-5} - 3.5 \times 10^{-5}} = 8$

Example: 113 The force between the plates of a parallel plate capacitor of capacitance C and distance of separation of the plates d with a potential difference V between the plates, is

- (a) $\frac{CV^2}{2d}$ (b) $\frac{C^2 V^2}{2d^2}$ (c) $\frac{C^2 V^2}{d^2}$ (d) $\frac{V^2 d}{C}$



Solution: (a) Since $F = \frac{Q^2}{2\epsilon_0 A} \Rightarrow F = \frac{C^2 V^2}{2\epsilon_0 A} = \frac{CV^2}{2d}$.

Example: 114 A capacitor when filled with a dielectric $K=3$ has charge Q_0 , voltage V_0 and field E_0 . If the dielectric is replaced with another one having $K = 9$, the new values of charge, voltage and field will be respectively

- (a) $3Q_0, 3V_0, 3E_0$ (b) $Q_0, 3V_0, 3E_0$ (c) $Q_0, \frac{V_0}{3}, 3E_0$ (d) $Q_0, \frac{V_0}{3}, \frac{E_0}{3}$

Solution: (d) Suppose, charge, potential difference and electric field for capacitor without dielectric medium are Q , V and E respectively

With dielectric medium of $K = 3$

Charge $Q_0 = Q$

Potential difference $V_0 = \frac{V}{3}$

Electric field $E_0 = \frac{E}{3}$

With dielectric medium of $K = 9$

Charge $Q' = Q = Q_0$

Potential difference $V' = \frac{V}{9} = \frac{V_0}{3}$

Electric field $E' = \frac{E}{9} = \frac{E_0}{3}$.

Example: 115 A slab of copper of thickness b is inserted in between the plates of parallel plate capacitor as shown in the figure. The separation between the plates is d . If $b = \frac{d}{2}$ then the ratio of capacities of the capacitor after and before inserting the slab will be

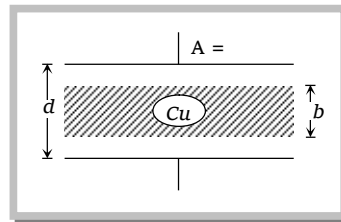

- (a) $\sqrt{2} : 1$ (b) $2 : 1$ (c) $1 : 1$ (d) $1 : \sqrt{2}$

Solution: (b) Capacitance before inserting the slab $C = \frac{\epsilon_0 A}{d}$ and capacitance after inserting the slab

$$C' = \frac{\epsilon_0 A}{d-t}$$

Where $t = b = \frac{d}{2}$ so $C' = \frac{2\epsilon_0 A}{d}$ hence, $\frac{C'}{C} = \frac{2}{1}$.

Example: 116 The capacity of a parallel plate condenser is C_0 . If a dielectric of relative permittivity ϵ_r and thickness equal to one fourth the plate separation is placed between the plates, then its capacity becomes C . The value of $\frac{C}{C_0}$ will be

- (a) $\frac{5\epsilon_r}{4\epsilon_r + 1}$ (b) $\frac{4\epsilon_r}{3\epsilon_r + 1}$ (c) $\frac{3\epsilon_r}{2\epsilon_r + 1}$ (d) $\frac{2\epsilon_r}{\epsilon_r + 1}$

Solution: (b) Initially capacitance $C_0 = \frac{\epsilon_0 A}{d}$ (i) Finally capacitance $C = \frac{\epsilon_0 A}{d - \frac{d}{4} + \frac{d}{4\epsilon_r}}$ (ii)

By dividing equation (ii) by equation (i) $\frac{C}{C_0} = \frac{4\epsilon_r}{3\epsilon_r + 1}$

Tricky example: 16

An air capacitor of capacity $C = 10 \mu F$ is connected to a constant voltage battery of 12 V. Now the space between the plates is filled with a liquid of dielectric constant 5. The charge that flows now from battery to the capacitor is

- (a) $120 \mu C$ (b) $600 \mu C$ (c) $480 \mu C$ (d) $24 \mu C$

Solution: (c) Initially charge on the capacitor $Q_i = 10 \times 12 = 120 \mu C$

When dielectric medium is filled, so capacitance becomes K times, i.e. new capacitance $C' = 5 \times 10 = 50 \mu C$

Final charge on the capacitor $Q_f = 50 \times 12 = 600 \mu C$

Hence additional charge supplied by the battery = $Q_f - Q_i = 480 \mu C$.

Grouping of Capacitors

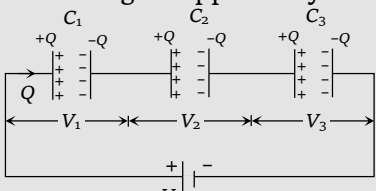
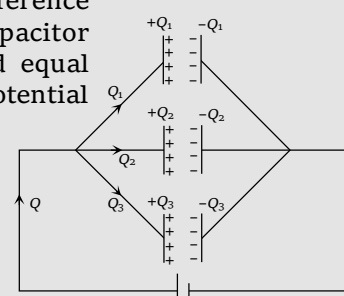
Series grouping	Parallel grouping
<p>(1) Charge on each capacitor remains same and equals to the main charge supplied by the battery</p>  <p>$V = V_1 + V_2 + V_3$</p>	<p>(1) Potential difference across each capacitor remains same and equal to the applied potential difference</p>  <p>$Q = Q_1 + Q_2 + Q_3$</p>
<p>(2) Equivalent capacitance</p> $\frac{1}{C_{eq}} = \frac{1}{C_1} + \frac{1}{C_2} + \frac{1}{C_3} \text{ or } C_{eq} = (C_1^{-1} + C_2^{-1} + C_3^{-1})^{-1}$	<p>(2) $C_{eq} = C_1 + C_2 + C_3$</p>
<p>(3) In series combination potential difference and energy distribution in the reverse ratio of capacitance i.e., $V \propto \frac{1}{C}$ and $U \propto \frac{1}{C}$.</p>	<p>(3) In parallel combination charge and energy distributes in the ratio of capacitance i.e. $Q \propto C$ and $U \propto C$</p>
<p>(4) If two capacitors having capacitances C_1 and C_2 are connected in series then</p> $C_{eq} = \frac{C_1 C_2}{C_1 + C_2} = \frac{\text{Multiplication}}{\text{Addition}}$ $V_1 = \left(\frac{C_1}{C_1 + C_2} \right) \cdot V \quad \text{and} \quad V_2 = \left(\frac{C_2}{C_1 + C_2} \right) \cdot V$	<p>(4) If two capacitors having capacitance C_1 and C_2 respectively are connected in parallel then</p> $C_{eq} = C_1 + C_2$ $Q_1 = \left(\frac{C_1}{C_1 + C_2} \right) \cdot Q \quad \text{and} \quad Q_2 = \left(\frac{C_2}{C_1 + C_2} \right) \cdot Q$
<p>(5) If n identical capacitors each having</p>	<p>(5) If n identical capacitors are connected in</p>



capacitances C are connected in series with supply voltage V then Equivalent capacitance

$C_{eq} = \frac{C}{n}$ and Potential difference across each capacitor $V' = \frac{V}{n}$.

parallel

Equivalent capacitance $C_{eq} = nC$ and Charge

on each capacitor $Q' = \frac{Q}{n}$

Redistribution of Charge Between Two Capacitors

When a charged capacitor is connected across an uncharged capacitor, then redistribution of charge occur to equalize the potential difference across each capacitor. Some energy is also wasted in the form of heat.

Suppose we have two charged capacitors C_1 and C_2 after disconnecting these two from their respective batteries. These two capacitors are connected to each other as shown below (positive plate of one capacitor is connected to positive plate of other while negative plate of one is connected to negative plate of other)

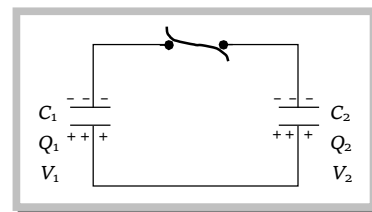

Charge on capacitors redistributed and new charge on them will be $Q_1' = Q \left(\frac{C_1}{C_1 + C_2} \right)$,

$$Q_2' = Q \left(\frac{C_2}{C_1 + C_2} \right)$$

The common potential $V = \frac{Q_1 + Q_2}{C_1 + C_2} = \frac{C_1 V_1 + C_2 V_2}{C_1 + C_2}$ and loss of energy $\Delta U = \frac{C_1 C_2}{2(C_1 + C_2)} (V_1 - V_2)^2$

Note : □ Two capacitors of capacitances C_1 and C_2 are charged to potential of V_1 and V_2 respectively. After disconnecting from batteries they are again connected to each other with reverse polarity *i.e.*, positive plate of a capacitor connected to negative plate of other. So common potential $V = \frac{Q_1 - Q_2}{C_1 + C_2} = \frac{C_1 V_1 - C_2 V_2}{C_1 + C_2}$.



Circuit With Resistors and Capacitors

(1) A resistor may be connected either in series or in parallel with the capacitor as shown below

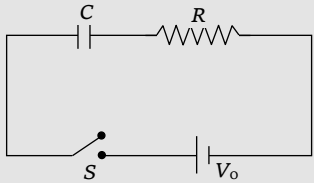
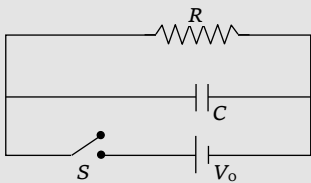
Series RC Circuit	Parallel RC Circuit
	
In this combination capacitor takes longer time to charge.	Resistor has no effect on the charging of capacitor.
The charging current is maximum in the beginning; it decreases with time and becomes zero after a long time.	Resistor provides an alternative path for the electric current.

(2) Three states of RC circuits

(i) Initial state : *i.e.*, just after closing the switch or just after opening the switch.

(ii) Transient state : or instantaneous state *i.e.*, any time after closing or opening the switch.

(iii) Steady state : *i.e.*, a long time after closing or opening the switch. In the steady state condition, the capacitor is charged or discharged.

(3) **Charging and discharging of capacitor in series RC circuit** : As shown in the following figure (i) when switch *S* is closed, capacitor start charging. In this transient state potential difference appears across capacitor as well as resistor. When capacitor gets fully charged the entire potential difference appeared across the capacitor and nothing is left for the resistor. [shown in figure (ii)]

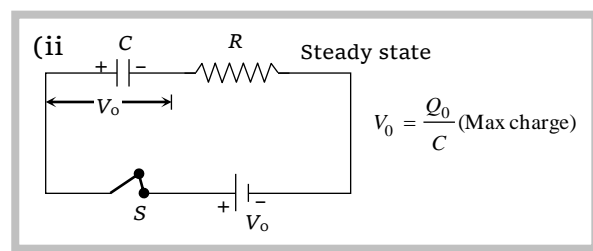
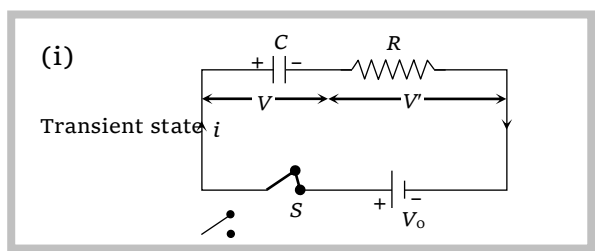

(i) **Charging** : In transient state of charging charge on the capacitor at any instant $Q = Q_0 \left(1 - e^{-\frac{t}{RC}} \right)$ and potential difference across the capacitor at any instant $V = V_0 \left(1 - e^{-\frac{t}{RC}} \right)$



(ii) **Discharging** : After the completion of charging, if battery is removed capacitor starts discharging. In transient state charge on the capacitor at any instant $Q = Q_0 e^{-t/RC}$ and potential difference across the capacitor at any instant $V = V_0 e^{-t/RC}$.

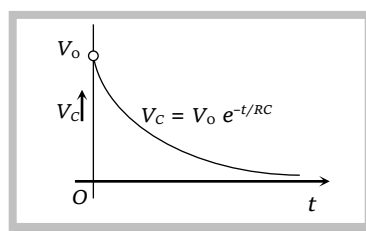
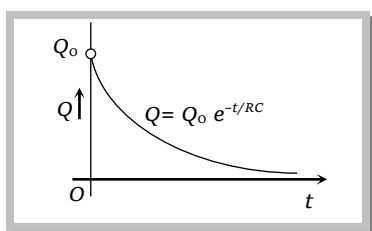

(iii) **Time constant (τ)** : The quantity RC is called the time constant *i.e.*, $\tau = RC$.

In charging : It is defined as the time during which charge on the capacitor rises to 0.63 times (63%) the maximum value. That is when $t = \tau = RC$, $Q = Q_0(1 - e^{-1}) = 0.639 Q_0$ **or**

In discharging : It is defined as the time during which charge on a capacitor falls to 0.37 times (37%) of the initial charge on the capacitor that is when $t = \tau = RC$, $Q = Q_0(e^{-1}) = 0.37 Q_0$

(iv) **Mixed RC circuit** : In a mixed RC circuit as shown below, when switch S is closed current flows through the branch containing resistor as well as through the branch contains capacitor and resistor (because capacitor is in the process of charging)

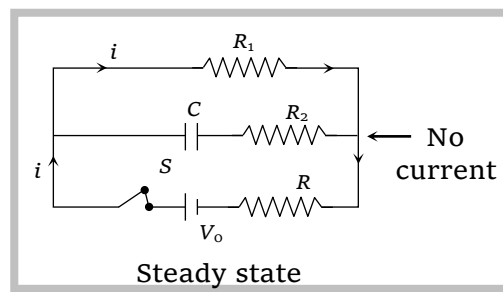
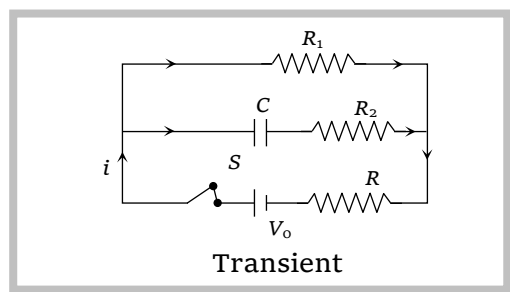

When capacitor gets fully charged (steady state), no current flows through the line in which capacitor is connected. Therefore the current through resistor R_1 is $\frac{V_0}{(R_1 + r)}$, hence potential

difference across resistance will be equal to $\frac{V_0}{(R_1 + r)} R_1$. The same potential difference will appear across the capacitor, hence charge on capacitor in steady state $Q = \frac{CV_0 R_1}{(R_1 + r)}$

Concepts

- ☞ In series combination equivalent capacitance is always lesser than that of either of the individual capacitors e.g. If two capacitors having capacitances $3\mu\text{F}$ and $6\mu\text{F}$ respectively are connected in series then equivalent capacitance

$$C_{eq} = \frac{3 \times 6}{3 + 6} = 2\mu\text{F}$$

Which is lesser than the smallest capacitance ($3\mu\text{F}$) of the network.

- ☞ In parallel combination, equivalent capacitance is always greater than the maximum capacitance of either capacitor in network.

- ☞ If n identical plates arranged as shown below, constitutes $(n - 1)$ capacitors in series. If each capacitor having capacitance $\frac{\epsilon_0 A}{d}$ then $C_{eq} = \frac{\epsilon_0 A}{(n-1)d}$

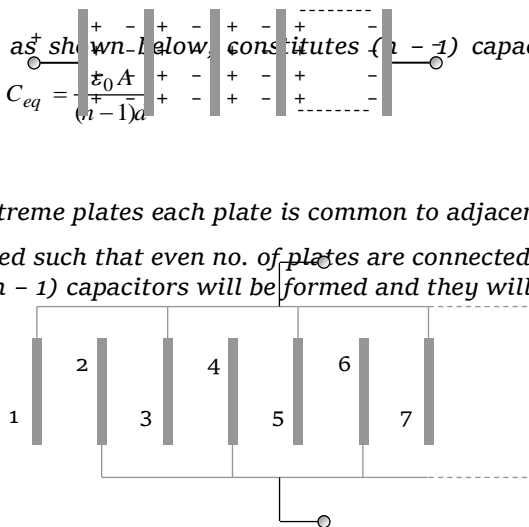

In this situation except two extreme plates each plate is common to adjacent capacitors.

- ☞ If n identical plates are arranged such that even no. of plates are connected together and odd number of plates are connected together, then $(n - 1)$ capacitors will be formed and they will be in parallel grouping.

Equivalent capacitance $C' = (n - 1)C$

Where $C = \text{capacitance of a capacitor} = \frac{\epsilon_0 A}{d}$

- ☞ If n identical capacitors are connected in parallel which are charged to a potential V . If these are separated and connected in series then potential difference of combination will be nV .

Network Solving

To solve capacitive network for equivalent capacitance following guidelines should be followed.

Guideline 1. Identify the two points across which the equivalent capacitance is to be calculated.

Guideline 2. Connect (Imagine) a battery between these points.

Guideline 3. Solve the network from the point (reference point) which is farthest from the points between which we have to calculate the equivalent capacitance. (The point is likely to be not a node)

(1) **Simple circuits** : Suppose equivalent capacitance is to be determined in the following networks between points A and B

Suppose equivalent capacitance is to be determined in the following networks between points A and B

(i)

(ii)

(iii)

By similar process $C_{AB} = 3\mu F$

(2) **Circuits with extra wire** : If there is no capacitor in any branch of a network then every point of this branch will be at same potential. Suppose equivalent capacitance is to be determine in following cases

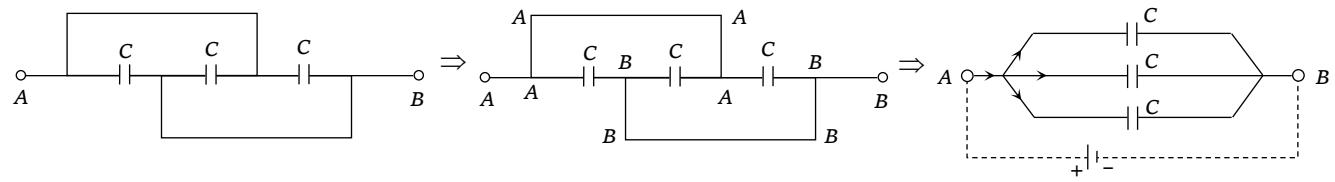
(i)  $C_{AB} = 3C$

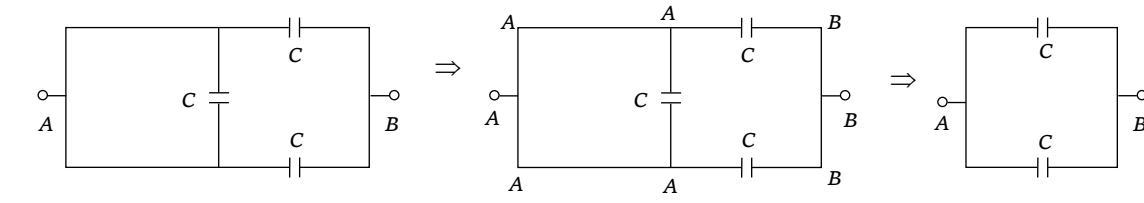
(ii)  No p.d. across vertical branch so it $C_{AB} = 2C$

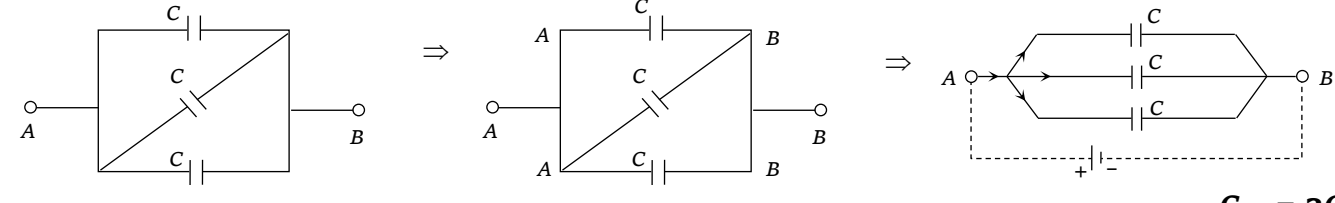
(iii)  $C_{AB} = 3C$

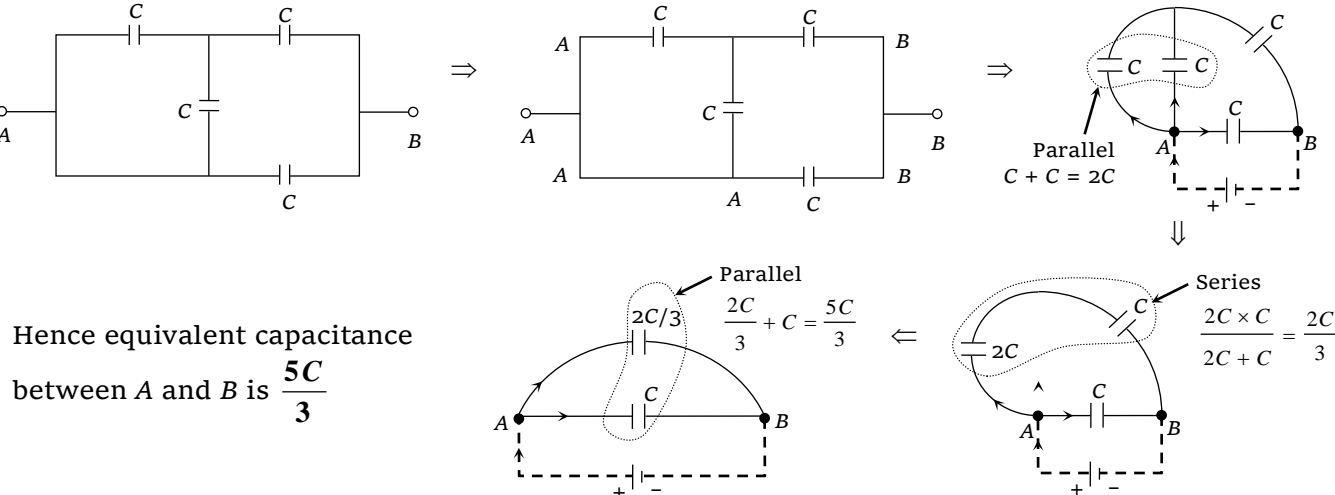
(iv)  Hence equivalent capacitance between A and B is $\frac{5C}{3}$

(v) Since there is no capacitor in the path APB, the points A, P and B are electrically same i.e., the input and output points are directly connected (short circuited). Thus, entire charge will prefer to flow along path APB. It means that the capacitors connected in the circuit will not receive any charge for storing. Thus

equivalent capacitance of this circuit is zero.

(3) **Wheatstone bridge based circuit** : If in a network five capacitors are arranged as shown in following figure, the network is called wheatstone bridge type circuit. If it is balanced then

$\frac{C_1}{C_2} = \frac{C_3}{C_4}$ hence C_5 is removed and equivalent capacitance between A and B

(i)

(ii)

(iii)

$$C_{AB} = \frac{C_1 C_2}{C_1 + C_2} + \frac{C_3 C_4}{C_3 + C_4}$$

(4) **Extended wheatstone bridge** : The given figure consists of two wheatstone bridge connected together. One bridge is connected between points *AEGHFA* and the other is connected between points *EGBHFE*.

This problem is known as extended wheatstone bridge problem, it has two branches *EF* and *GH* to the left and right of which symmetry in the ratio of capacities can be seen.

It can be seen that ratio of capacitances in branches *AE* and *EG* is same as that between the capacitances of the branches *AF* and *FH*. Thus, in the bridge *AEGHFA*; the branch *EF* can be removed. Similarly in the bridge *EGBHFE* branch *GH* can be removed

\Rightarrow

$$C_{AB} = \frac{2C}{3}$$

(5) **Infinite chain of capacitors** : In the following figure equivalent capacitance between A and B

(i)

Suppose the effective capacitance between A and B is C_R . Since the network is infinite, even if we remove one pair of capacitors from the chain, remaining network would still have infinite pair of capacitors, i.e., effective

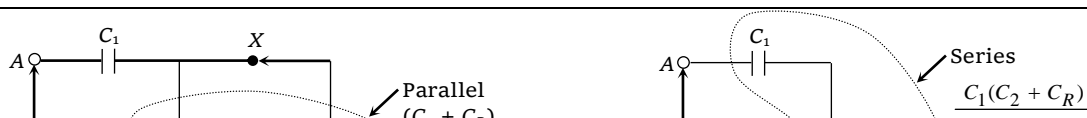

capacitance between X and Y would also be C_R

Hence equivalent capacitance between A and B

$$C_{AB} = \frac{C_1(C_2 + C_R)}{C_1 + C_2 + C_R} = C_R \Rightarrow C_{AB} = \frac{C_2}{2} \left[\sqrt{\left(1 + 4 \frac{C_1}{C_2}\right)} - 1 \right]$$

(ii) For what value of C_0 in the circuit shown below will the net effective capacitance between A and B be independent of the number of sections in the chain

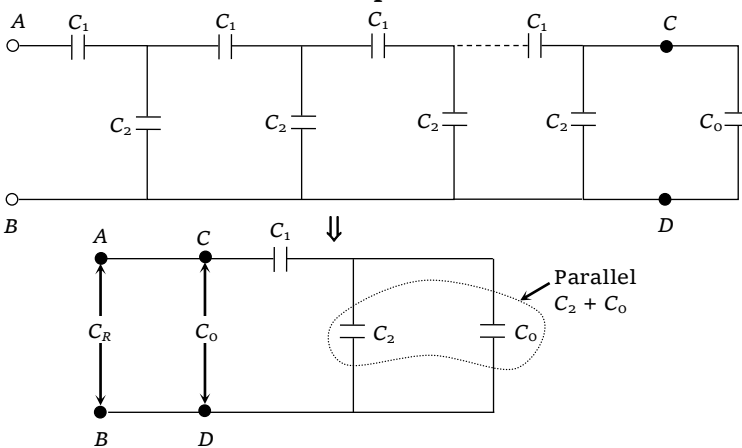

Suppose there are n sections between A and B and the network is terminated by C_0 with equivalent capacitance C_R . Now if we add one more sections to the network between D and C (as shown in the following figure), the equivalent capacitance of the network C_R will be independent of number of sections if the capacitance between D and C still remains C_0 i.e.,

Hence
$$C_0 = \frac{C_1 \times (C_2 + C_0)}{C_1 + C_2 + C_0} \Rightarrow$$

$$C_0^2 + C_2 C_0 - C_1 C_2 = 0$$

On simplification
$$C_0 = \frac{C_2}{2} \left[\sqrt{\left(1 + 4 \frac{C_1}{C_2}\right)} - 1 \right]$$

(6) Network with more than one cell :

(i)

Potential difference across C_1 is $\left(\frac{C_2}{C_1 + C_2}\right)(E_1 - E_2)$ and potential difference across C_2 is $\left(\frac{C_1}{C_1 + C_2}\right)(E_1 - E_2)$

(ii) Potential difference between the ends of this arrangement is given V.

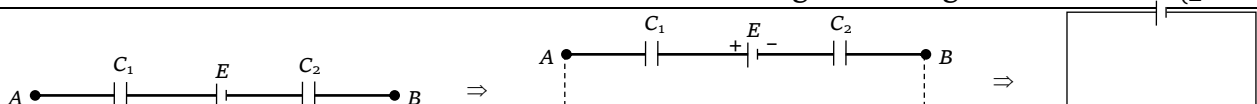

(7) **Advance case of compound dielectrics** : If several dielectric medium filled between the plates of a parallel plate capacitor in different ways as shown.

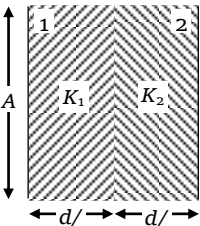
(i)  The system can be assumed to be made up of two capacitors C_1 and C_2 which may be said to connected in series

$$C_1 = \frac{K_1 \varepsilon_0 A}{\frac{d}{2}}, \quad C_2 = \frac{K_2 \varepsilon_0 A}{\frac{d}{2}} \quad \text{and} \quad \frac{1}{C_{eq}} = \frac{1}{C_1} + \frac{1}{C_2} \Rightarrow C_{eq} = \left(\frac{2K_1 K_2}{K_1 + K_2} \right) \cdot \frac{\varepsilon_0 A}{d}$$

Also $K_{eq} = \frac{2K_1 K_2}{K_1 + K_2}$

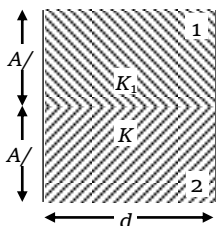
(ii)  In this case these two capacitors are in parallel and

$$C_1 = \frac{K_1 \varepsilon_0 A}{2d}, \quad C_2 = \frac{K_2 \varepsilon_0 A}{2d}$$

Hence, $C_{eq} = C_1 + C_2 \Rightarrow C_{eq} = \left(\frac{K_1 + K_2}{2} \right) \cdot \frac{\varepsilon_0 A}{d}$

Also $K_{eq} = \frac{K_1 + K_2}{2}$

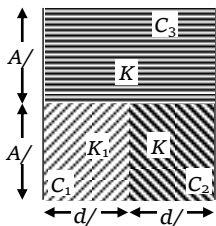
(iii)  In this case C_1 and C_2 are in series while this combination is in parallel with C_3

$$C_1 = \frac{K_1 \varepsilon_0 \frac{A}{2}}{\frac{d}{2}} = \frac{K_1 \varepsilon_0 A}{d}, \quad C_2 = \frac{K_2 \varepsilon_0 \frac{A}{2}}{\frac{d}{2}} = \frac{K_2 \varepsilon_0 A}{d} \quad \text{and} \quad C_3 = \frac{K_3 \varepsilon_0 \frac{A}{2}}{\frac{d}{2}} = \frac{K_3 \varepsilon_0 A}{2d}$$

Hence, $C_{eq} = \frac{C_1 C_2}{C_1 + C_2} + C_3 = \frac{\frac{k_1 \varepsilon_0 A}{d} \times \frac{k_2 \varepsilon_0 A}{d}}{\frac{k_1 \varepsilon_0 A}{d} + \frac{k_2 \varepsilon_0 A}{d}} + \frac{k_3 \varepsilon_0 A}{2d} \Rightarrow$

$$C_{eq} = \left(\frac{k_1 k_2}{k_1 + k_2} + \frac{k_3}{2} \right) \cdot \frac{\varepsilon_0 A}{d}$$

Also $k_{eq} = \left(\frac{k_3}{2} + \frac{k_1 k_2}{k_1 + k_2} \right)$





Example based on series and parallel grouping of

Example: 117 Three capacitors of $2\mu f$, $3\mu f$ and $6\mu f$ are joined in series and the combination is charged by means of a 24 volt battery. The potential difference between the plates of the $6\mu f$ capacitor is

[MP PMT 2002 Similar to MP PMT 1996]

- (a) 4 volts (b) 6 volts (c) 8 volts (d) 10 volts

Solution: (a) Equivalent capacitance of the network is $\frac{1}{C_{eq}} = \frac{1}{2} + \frac{1}{3} + \frac{1}{6}$

$$C_{eq} = 1\mu F$$

Charge supplied by battery $Q = C_{eq} \cdot V \Rightarrow 1 \times 24 = 24 \mu C$

Hence potential difference across $6\mu F$ capacitor = $\frac{24}{6} = 4$ volt.

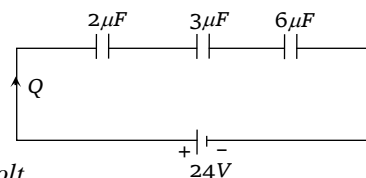

Example: 118 Two capacitors each of $1\mu f$ capacitance are connected in parallel and are then charged by 200 V D.C. supply. The total energy of their charges in joules is

- (a) 0.01 (b) 0.02 (c) 0.04 (d) 0.06

Solution: (c) By using formula $U = \frac{1}{2} C_{eq} V^2$

Here $C_{eq} = 2\mu F$

$$\therefore U = \frac{1}{2} \times 2 \times 10^{-6} \times (200)^2 = 0.04 J$$

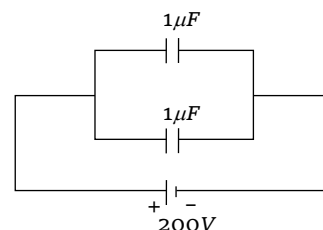

Example: 119 Five capacitors are connected as shown in the figure. The equivalent capacitance between the point A and B is

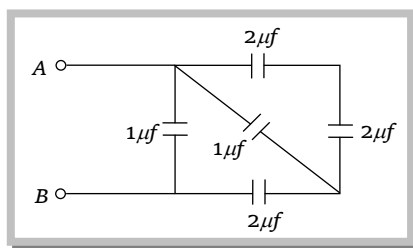

[MP PMT 2002; SCRA 1996; Pantnagar 1987]

- (a) $1\mu f$ (b) $2\mu f$ (c) $3\mu f$ (d) $4\mu f$

Solution: (b)

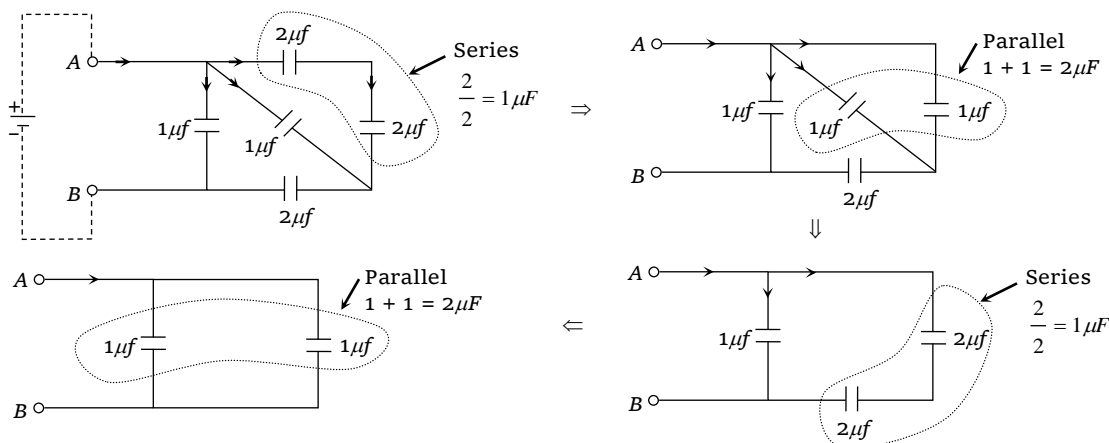

Hence equivalent capacitance between A and B is $2\mu F$.

Example: 120 In the following network potential difference across capacitance of $4.5\mu F$ is [RPET 2001; MP PET 199]

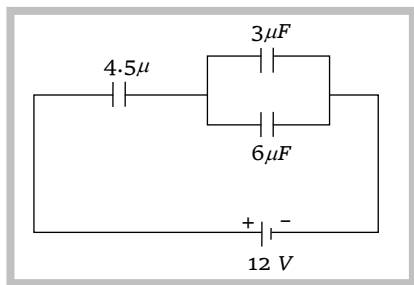

(a) 8 V

(b) 4 V

(c) 2 V

Solution: (a) Equivalent capacitance $C_{eq} = \frac{9 \times 4.5}{9 + 4.5} = 3\mu F$

Charge supplied by battery $Q = C_{eq} \times V = 3 \times 12 = 36\mu C$

Hence potential difference across $4.5\mu F = \frac{36}{4.5} = 8V$.

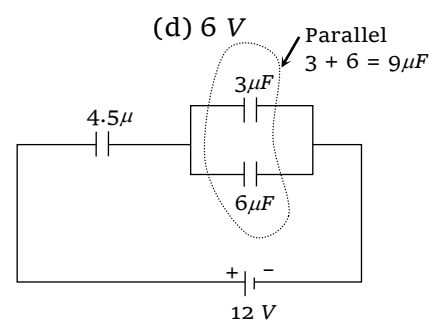

Example: 121 A parallel plate capacitor of area A , plate separation d and capacitance C is filled with three different dielectric materials having dielectric constants K_1 , K_2 and K_3 as shown in fig. If a single dielectric material is to be used to have the same capacitance C in this capacitor, then its dielectric constant K is given by [IIT Screening 2000]

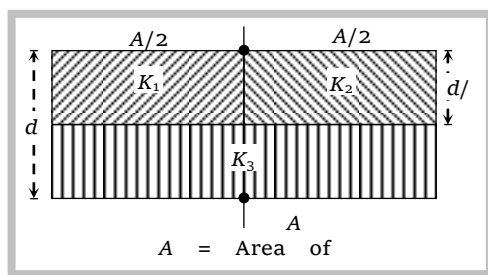

(a) $\frac{1}{K} = \frac{1}{K_1} + \frac{1}{K_2} + \frac{1}{2K_3}$

(b) $\frac{1}{K} = \frac{1}{K_1 + K_2} + \frac{1}{2K_3}$

(c) $K = \frac{K_1 K_2}{K_1 + K_2} + 2K_3$

(d) $K = K_1 + K_2 + 2K_3$

Solution: (b) The effective capacitance is given by $\frac{1}{C_{eq}} = \frac{d}{\epsilon_0 A} \left[\frac{1}{2K_3} + \frac{1}{(K_1 + K_2)} \right]$

The capacitance of capacitor with single dielectric of dielectric constant K is $C = \frac{K\epsilon_0 A}{d}$

According to question $C_{eq} = C$ i.e., $\frac{\epsilon_0 A}{d \left[\frac{1}{2K_3} + \frac{1}{K_1 + K_2} \right]} = \frac{K\epsilon_0 A}{d}$

$\Rightarrow \frac{1}{K} = \frac{1}{2K_3} + \frac{1}{K_1 + K_2}$.

Example: 122 Two capacitors $C_1 = 2\mu F$ and $C_2 = 6\mu F$ in series, are connected in parallel to a third capacitor $C_3 = 4\mu F$. This arrangement is then connected to a battery of e.m.f. = 2 V, as shown in the fig. How much energy is lost by the battery in charging the capacitors ?

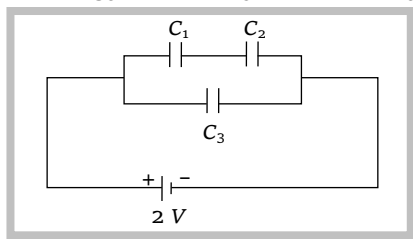

- (a) $22 \times 10^{-6} J$ (b) $11 \times 10^{-6} J$ (c) $\left(\frac{32}{3}\right) \times 10^{-6} J$ (d) $\left(\frac{16}{3}\right) \times 10^{-6} J$

Solution: (b) Equivalent capacitance $C_{eq} = \frac{C_1 C_2}{C_1 + C_2} + C_3 = \frac{2 \times 6}{8} + 4 = 5.5 \mu F$

$\therefore U = \frac{1}{2} C_{eq} \cdot V^2 = \frac{1}{2} \times 5.5 \times (2)^2 = 11 \times 10^{-6} J$

Example: 123 In the circuit shown in the figure, each capacitor has a capacity of $3\mu F$. The equivalent capacity between A and B is

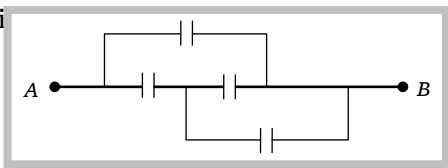

- (a) $\frac{3}{4} \mu F$ (b) $3 \mu F$ (c) $6 \mu F$ (d) $5 \mu F$

Solution: (d)

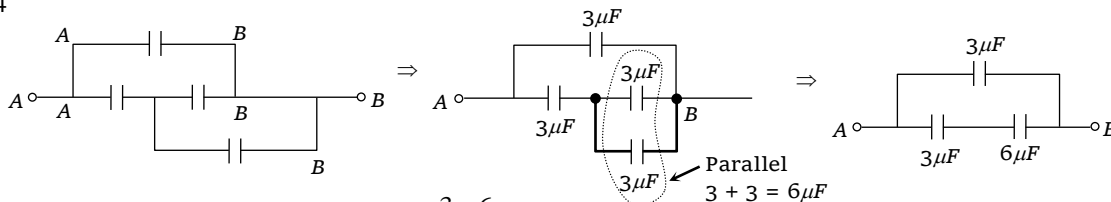

Hence equivalent capacitance $C_{eq} = \frac{3 \times 6}{3 + 6} + 3 = 5 \mu F$.

Example: 124 Given a number of capacitors labelled as $8\mu F$, 250 V. Find the minimum number of capacitors needed to get an arrangement equivalent to $16 \mu F$, 1000 V

- (a) 4 (b) 16 (c) 32 (d) 64

Solution: (c) Let $C = 8 \mu F$, $C' = 16 \mu F$ and $V = 250$ volt, $V' = 1000$ V

Suppose m rows of given capacitors are connected in parallel which each row contains n capacitor then

Potential difference across each capacitors $V = \frac{V'}{n}$ and equivalent capacitance of network

$$C' = \frac{mC}{n}$$

On putting the values, we get $n = 4$ and $m = 8$. Hence total capacitors = $m \times n = 8 \times 4 = 32$.

Short Trick : For such type of problem number of capacitors $n = \frac{C'}{C} \times \left(\frac{V'}{V}\right)^2$. Here

$$n = \frac{16}{8} \left(\frac{1000}{250}\right)^2 = 32$$

Example: 125 Ten capacitors are joined in parallel and charged with a battery up to a potential V . They are then disconnected from battery and joined again in series then the potential of this combination will be [RPET 2000]

- (a) V (b) $10 V$ (c) $5 V$ (d) $2 V$

Solution: (b) By using the formula $V' = nV \Rightarrow V' = 10 V$.

Example: 126 For the circuit shown, which of the following statements is true

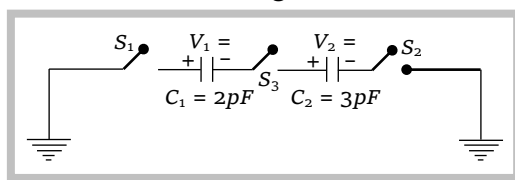

- (a) With S_1 closed, $V_1 = 15 V$, $V_2 = 20 V$ (b) With S_3 closed, $V_1 = V_2 = 25 V$
 (c) With S_1 and S_2 closed $V_1 = V_2 = 0$ (d) With S_1 and S_3 closed $V_1 = 30 V$, $V_2 = 20 V$

Solution: (d) When S_3 is closed, due to attraction with opposite charge, no flow of charge takes place through S_3 . Therefore, potential difference across capacitor plates remains unchanged or $V_1 = 30 V$ and $V_2 = 20 V$.

Alternate Solution

Charges on the capacitors are - $q_1 = (30)(2) = 60 pC$, $q_2 = (20)(3) = 60 pC$ or $q_1 = q_2 = q$ (say)

The situation is similar as the two capacitors in series are first charged with a battery of emf $50 V$ and then disconnected.

When S_3 is closed, $V_1 = 30 V$ and $V_2 = 20 V$.

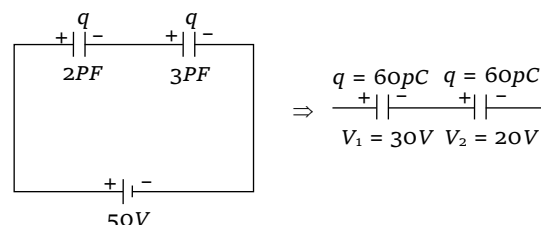

Example: 127 A finite ladder is constructed by connecting several sections of $2 \mu F, 4 \mu F$ capacitor combinations as shown in the figure. It is terminated by a capacitor of capacitance C . What value should be chosen for C , such that the equivalent capacitance of the ladder is independent of the number of sections in between [MP PMT 1999]

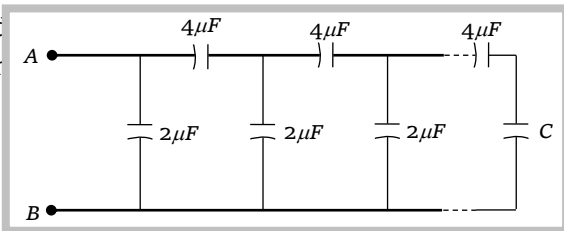

- (a) $4\mu F$ (b) $2\mu F$ (c) $18\mu F$ (d) $6\mu F$

Solution: (a) By using formula $C = \frac{C_2}{2} \left[\sqrt{1 + 4\left(\frac{C_1}{C_2}\right)} + 1 \right]$; $C_1 = 4\mu F$ We get
 $C_2 = 2\mu F$
 $C = 4\mu F$.

Example: 128 Figure shows two capacitors connected in series and joined to a battery. The graph shows the variation in potential as one moves from left to right on the branch containing the capacitors.

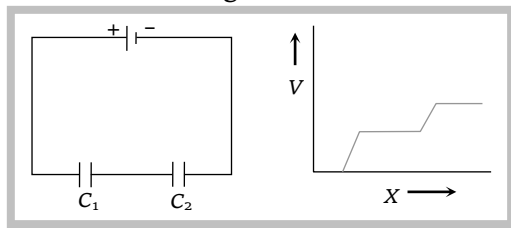

- (a) $C_1 > C_2$
 (b) $C_1 = C_2$
 (c) $C_1 < C_2$
 (d) The information is insufficient to decide the relation between C_1 and C_2

Solution: (c) According to graph we can say that potential difference across the capacitor C_1 is more than that across C_2 . Since charge Q is same i.e., $Q = C_1 V_1 = C_2 V_2 \Rightarrow \frac{C_1}{C_2} = \frac{V_2}{V_1} \Rightarrow C_1 < C_2$ ($V_1 > V_2$).

Example: 129 Two condensers of capacity C and $2C$ are connected in parallel and these are charged upto V volt. If the battery is removed and dielectric medium of constant K is put between the plates of first condenser, then the potential at each condenser is

- (a) $\frac{V}{K+2}$ (b) $2 + \frac{K}{3V}$ (c) $\frac{2V}{K+2}$ (d) $\frac{3V}{K+2}$

Solution: (d) Initially

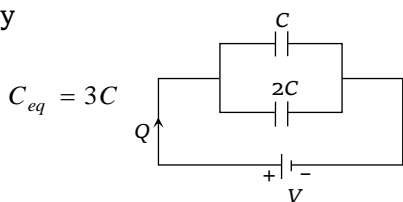

Equivalent capacitance of the system

Total charge $Q = (3C)V$

Finally

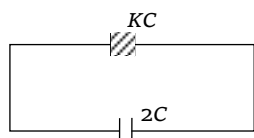

Equivalent capacitance of the system

$C_{eq} = KC + 2C$

Hence common potential $V = \frac{Q}{(KC + 2C)} = \frac{3CV}{(K + 2)C} = \frac{3V}{K + 2}$.

Example: 130 Condenser A has a capacity of $15\mu F$ when it is filled with a medium of dielectric constant 15. Another condenser B has a capacity $1\mu F$ with air between the plates. Both are charged separately by a battery of $100V$. After charging, both are connected in parallel without the battery and the dielectric material being removed. The common potential now is

- (a) 400V (b) 800V (c) 1200V (d) 1600V

Solution: (b) Charge on capacitor A is given by $Q_1 = 15 \times 10^{-6} \times 100 = 15 \times 10^{-4} C$

Charge on capacitor B is given by $Q_2 = 1 \times 10^{-6} \times 100 = 10^{-4} C$

Capacity of capacitor A after removing dielectric $= \frac{15 \times 10^{-6}}{15} = 1 \mu F$

Now when both capacitors are connected in parallel their equivalent capacitance will be $C_{eq} = 1 + 1 = 2 \mu F$

So common potential $= \frac{(15 \times 10^{-4}) + (1 \times 10^{-4})}{2 \times 10^{-6}} = 800 V$.

Example: 131 A capacitor of $20 \mu F$ is charged upto 500V is connected in parallel with another capacitor of $10 \mu F$ which is charged upto 200V. The common potential is

- (a) 500V (b) 400V (c) 300V (d) 200V

Solution: (b) By using $V = \frac{C_1 V_1 + C_2 V_2}{C_1 + C_2}$; $C_1 = 20 \mu F$, $V_1 = 500 V$, $C_2 = 10 \mu F$ and $V_2 = 200 V$

$$V = \frac{20 \times 500 + 10 \times 200}{20 + 10} = 400 V.$$

Example: 132 In the circuit shown

[DCE 1995]

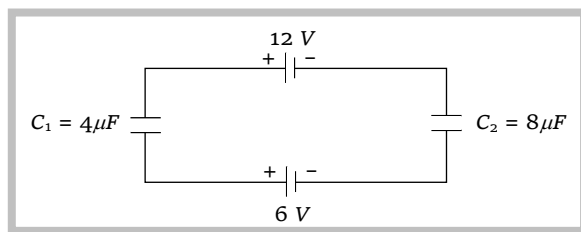

- (a) The charge on C_2 is greater than that of C_1 (b) The charge on C_2 is smaller than that of C_1
 (c) The potential drop across C_1 is smaller than C_2 (d) The potential drop across C_1 is greater than C_2

Solution: (d) Given circuit can be redrawn as follows

$$C_{eq} = \frac{4 \times 8}{12} = \frac{8}{3} \mu F$$

$$\text{So } Q = \frac{8}{3} \times 6 = 16 \mu C$$

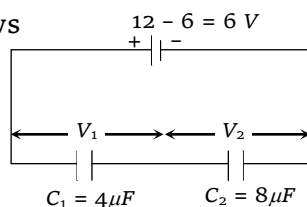

Hence potential difference $V_1 = \frac{16}{4} = 4 \text{ volt}$ and $V_2 = \frac{16}{8} = 2 \text{ volt}$ i.e. $V_1 > V_2$

Example: 133 As shown in the figure two identical capacitors are connected to a battery of V volts in parallel. When capacitors are fully charged, their stored energy is U_1 . If the key K is opened and a material of dielectric constant $K = 3$ is inserted in each capacitor, their stored energy is now U_2 . $\frac{U_2}{U_1}$

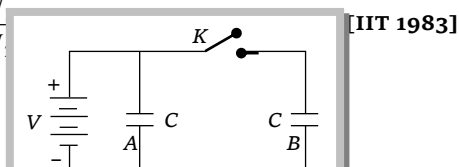

[IIT 1983]

- (a) $\frac{3}{5}$ (b) $\frac{5}{3}$ (c) 3 (d) $\frac{1}{3}$

Solution: (a) Initially potential difference across both the capacitor is same hence energy of the system is

$$U_1 = \frac{1}{2} CV^2 + \frac{1}{2} CV^2 = CV^2 \quad \dots\dots(i)$$

In the second case when key K is opened and dielectric medium is filled between the plates, capacitance of both the capacitors becomes $3C$, while potential difference across A is V and potential difference across B is $\frac{V}{3}$ hence energy of the system now is

$$U_2 = \frac{1}{2} (3C)V^2 + \frac{1}{2} (3C)\left(\frac{V}{3}\right)^2 = \frac{10}{6} CV^2 \quad \dots\dots(ii)$$

So, $\frac{U_1}{U_2} = \frac{3}{5}$

Example: 134 In the following figure the resultant capacitance between A and B is $1\mu F$. The capacitance C is [IIT 1977]

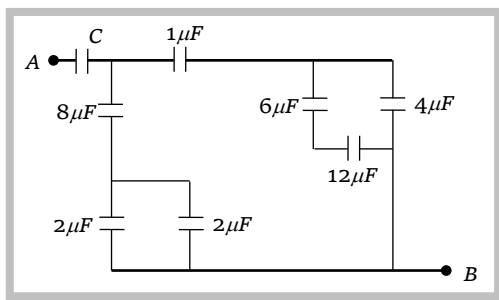

- (a) $\frac{32}{11} \mu F$ (b) $\frac{11}{32} \mu F$ (c) $\frac{23}{32} \mu F$ (d) $\frac{32}{23} \mu F$

Solution: (d) Given network can be simplified as follows

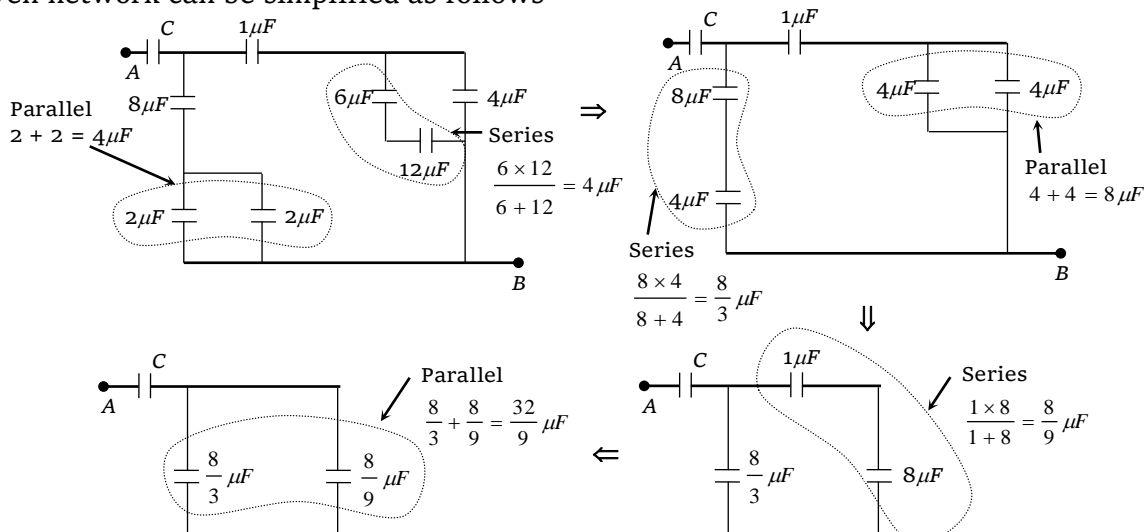

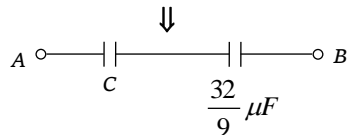

Given that equivalent capacitance between A and B i.e., $C_{AB} = 1 \mu F$

$$\text{But } C_{AB} = \frac{C \times \frac{32}{9}}{C + \frac{32}{9}} \text{ hence } \frac{C \times \frac{32}{9}}{C + \frac{32}{9}} = 1 \Rightarrow C = \frac{32}{23} \mu F.$$

Example: 135 A $1 \mu F$ capacitor and a $2 \mu F$ capacitor are connected in parallel across a 1200 volts line. The charged capacitors are then disconnected from the line and from each other. These two capacitors are now connected to each other in parallel with terminals of unlike signs together. The charges on the capacitors will now be

- (a) $1800 \mu C$ each (b) $400 \mu C$ and $800 \mu C$ (c) $800 \mu C$ and $400 \mu C$ (d) $800 \mu C$ and $800 \mu C$

Solution: (b) Initially charge on capacitors can be calculated as follows

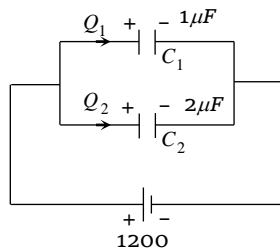

$$Q_1 = 1 \times 1200 = 1200 \mu C \text{ and } Q_2 = 2 \times 1200 = 2400 \mu C$$

Finally when battery is disconnected and unlike plates are connected together then common potential

$$V' = \frac{Q_2 - Q_1}{C_1 + C_2} = \frac{2400 - 1200}{1 + 2} = 400 \text{ V}$$

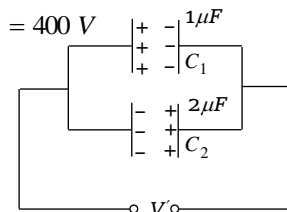

Hence, New charge on C_1 is $1 \times 400 = 400 \mu C$

And New charge on C_2 is $2 \times 400 = 800 \mu C$.

Example: 136 The two condensers of capacitances $2 \mu F$ and $3 \mu F$ are in series. The outer plate of the first condenser is at 1000 volts and the outer plate of the second condenser is earthed. The potential of the inner plate of each condenser is

- (a) 300 volts (b) 500 volts (c) 600 volts (d) 400 volts

Solution: (d) Here, potential difference across the combination is $V_A - V_B = 1000 \text{ V}$

$$\text{Equivalent capacitance } C_{eq} = \frac{2 \times 3}{2 + 3} = \frac{6}{5} \mu F$$

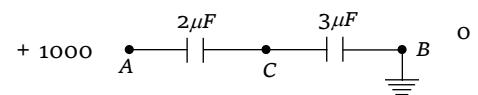

Hence, charge on each capacitor will be $Q = C_{eq} \times (V_A - V_B) = \frac{6}{5} \times 1000 = 1200 \mu C$

So potential difference between A and C, $V_A - V_C = \frac{1200}{2} = 600 \text{ V} \Rightarrow 1000 - V_C = 600 \Rightarrow V_C = 400 \text{ V}$

Example: 137 Four identical capacitors are connected in series with a 10V battery as shown in the figure. The point N is earthed. The potentials of points A and B are

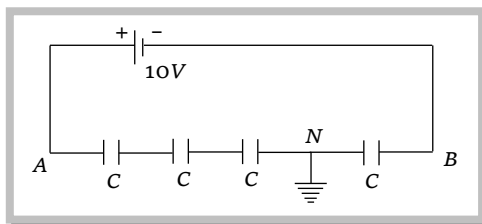

- (a) 10V,0V (b) 7.5V – 2.5V (c) 5V – 5V (d) 7.5V,2.5V

Solution: (b) Potential difference across each capacitor will be $\frac{10}{4} = 2.5V$

Hence potential difference between A & N i.e., $V_A - V_N = 2.5 + 2.5 + 2.5 = 7.5V$

$\Rightarrow V_A - 0 = V_A = 7.5V$ While $V_N - V_B = 2.5 \Rightarrow 0 - V_B = 2.5 \Rightarrow V_B = -2.5V$

Example: 138 In the figure below, what is the potential difference between the points A and B and between B and C respectively in steady state

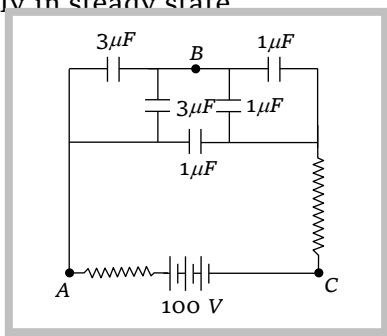

- (a) 100 volts both (b) $V_{AB} = 75$ volts, $V_{BC} = 25$ volts
 (c) $V_{AB} = 25$ volts, $V_{BC} = 75$ volts (d) $V_{AB} = 50$ volts $V_{BC} = 50$ volts

Solution: (c) In steady state No current flows in the given circuit hence resistances can be eliminated

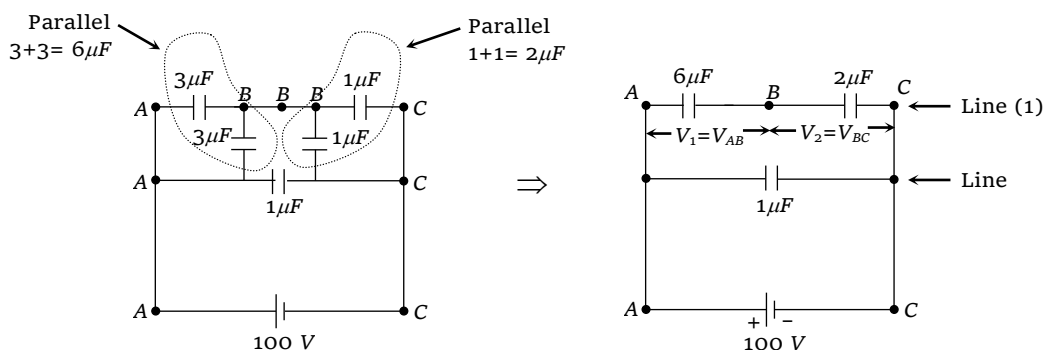

By using the formula to find potential difference in series combination of two capacitor

$$\left(V_1 = \left(\frac{C_2}{C_1 + C_2} \right) \cdot V \text{ and } V_2 = \frac{C_1}{C_2 + C_1} V \right)$$

$$V_1 = V_{AB} = \left(\frac{2}{2+6} \right) \times 100 = 25V ; \quad V_2 = V_{BC} = \left(\frac{6}{2+6} \right) \times 100 = 75V.$$

Example: 139 A capacitor of capacitance $5\mu F$ is connected as shown in the figure. The internal resistance of the cell is 0.5Ω . The amount of charge on the capacitor plate is

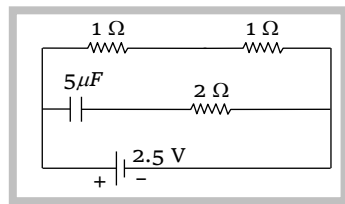

- (a) $0 \mu C$ (b) $5 \mu C$ (c) $10 \mu C$ (d) $25 \mu C$

Solution: (c) In steady state current drawn from the battery

$$i = \frac{2.5}{(1+1+0.5)} = 1A$$

In steady state capacitor is fully charged hence No current will flow through line (2)

Hence potential difference across line (1) is $V = 1 \times 2 = 2 \text{ volt}$, the same potential difference appears across the capacitor, so charge on capacitor $Q = 5 \times 2 = 10 \mu C$

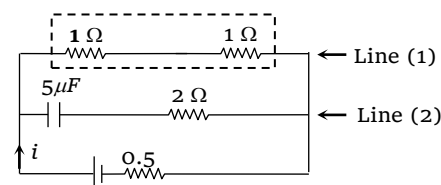

Example: 140 When the key K is pressed at time $t = 0$. Which of the following statements about the current i in the resistor AB of the adjoining circuit is true

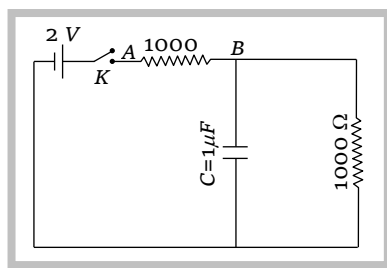

- (a) $i = 2mA$ at all t (b) i oscillates between $1mA$ and $2mA$
 (c) $i = 1mA$ at all t (d) At $t = 0$, $i = 2mA$ and with time it goes to $1mA$

Solution: (d) At $t = 0$ whole current passes through capacitance; so effective resistance of circuit is 1000Ω and current $i = \frac{2}{1000} = 2 \times 10^{-3} A = 2mA$. After sufficient time, steady state is reached; then there is no current in capacitor branch; so effective resistance of circuit is $1000 + 1000 = 2000 \Omega$ and current $i = \frac{2}{2000} = 1 \times 10^{-3} A = 1mA$ i.e., current is $2mA$ at $t = 0$ and with time it goes to $1mA$.

Example: 141 The plates of a capacitor are charged to a potential difference of 320 volts and are then connected across a resistor. The potential difference across the capacitor decays exponentially with time. After 1 second the potential difference between the plates of the capacitor is 240 volts , then after 2 and 3 seconds the potential difference between the plates will be

[MP PET 1998]

- (a) 200 and 180 volts (b) 180 and 135 volts (c) 160 and 80 volts (d) 140 and 20 volts

Solution: (b) During discharging potential difference across the capacitor falls exponentially as $V = V_0 e^{-\lambda t}$ ($\lambda = 1/RC$)

Where V = Instantaneous P.D. and V_0 = max. P.D. across capacitor

After 1 second $V_1 = 320 (e^{-\lambda}) \Rightarrow 240 = 320 (e^{-\lambda}) \Rightarrow e^{-\lambda} = \frac{3}{4}$

After 2 seconds $V_2 = 320 (e^{-\lambda})^2 \Rightarrow 320 \times \left(\frac{3}{4}\right)^2 = 180 \text{ volt}$

After 3 seconds $V_3 = 320 (e^{-\lambda})^3 = 320 \times \left(\frac{3}{4}\right)^3 = 135 \text{ volt}$

Example: 142 Five similar condenser plates, each of area A . are placed at equal distance d apart and are connected to a source of e.m.f E as shown in the following diagram. The charge on the plates 1 and 4 will be

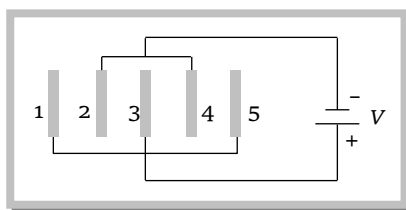

- (a) $\frac{\epsilon_0 A}{d}, \frac{-2\epsilon_0 A}{d}$ (b) $\frac{\epsilon_0 AV}{d}, \frac{-2\epsilon_0 AV}{d}$ (c) $\frac{\epsilon_0 AV}{d}, \frac{-3\epsilon_0 AV}{d}$ (d) $\frac{\epsilon_0 AV}{d}, \frac{-4\epsilon_0 AV}{d}$

Solution: (b) Here five plates are given, even number of plates are connected together while odd number of plates are connected together so, four capacitors are formed and they are in parallel combination, hence redrawing the figure as shown below.

Capacitance of each

Capacitor is $C = \frac{\epsilon_0 A}{d}$

Potential difference across each capacitor is V

So charge on each capacitor $Q = \frac{\epsilon_0 AV}{d} V$

Charge on plate (1) is $+\frac{\epsilon_0 AV}{d}$

While charge on plate 4 is $-\frac{\epsilon_0 AV}{d} \times 2 = -\frac{2\epsilon_0 AV}{d}$.

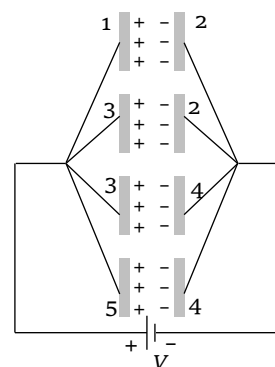

Example: 143 Four plates are arranged as shown in the diagram. If area of each plate is A and the distance between two neighbouring parallel plates is d , then the capacitance of this system between A and B will be

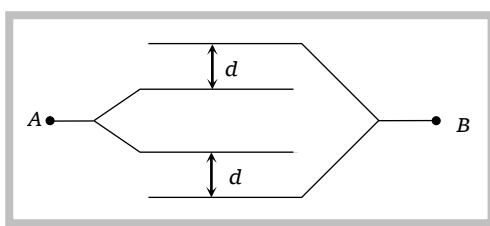

- (a) $\frac{4\epsilon_0 A}{d}$ (b) $\frac{3\epsilon_0 A}{d}$ (c) $\frac{2\epsilon_0 A}{d}$ (d) $\frac{\epsilon_0 A}{d}$

Solution: (c) To solve such type of problem following guidelines should be follows

Guideline 1. Mark the number (1,2,3.....) on the plates

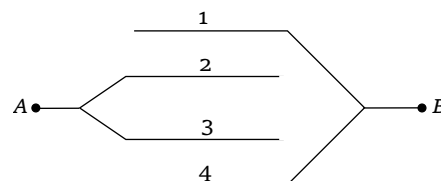

Guideline 2. Rearrange the diagram as shown below

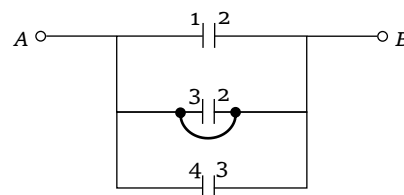

Guideline 3. Since middle capacitor having plates 2, 3 is short circuited so it should be eliminated from the circuit

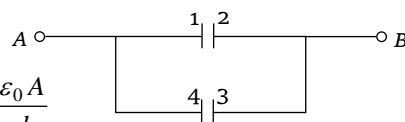

Hence equivalent capacitance between A and B $C_{AB} = 2 \frac{\epsilon_0 A}{d}$

Tricky example: 17

A capacitor of capacitance $C_1 = 1\mu F$ can withstand maximum voltage $V_1 = 6\text{ KV}$ (kilo-volt) and another capacitor of capacitance $C_2 = 3\mu F$ can withstand maximum voltage $V_2 = 4\text{ KV}$. When the two capacitors are connected in series, the combined system can withstand a maximum voltage of

[MP PET 2001]

(a) 4 KV

(b) 6 KV

(c) 8 KV

(d) 10 KV

Solution: (c) We know $Q = CV$

Hence $(Q_1)_{\max} = 6\text{ mC}$ while $(Q_2)_{\max} = 12\text{ mC}$

However in series charge is same so maximum charge on C_2 will also be 6 mC (and not 12 mC) and hence potential difference across C_2 will be $V_2 = \frac{6\text{ mC}}{3\mu F} = 2\text{ KV}$ and as in series $V =$

$V_1 + V_2$

So $V_{\max} = 6\text{ KV} + 2\text{ KV} = 8\text{ KV}$